

# WAZIUP: DEPLOYING LOW-COST IOT IN DEVELOPING COUNTRIES

SEMINAR AT LIG, GRENOBLE, FRANCE  
APRIL 24<sup>TH</sup>, 2018

DISRUPTIVE  
INTERNET  
OF THINGS  
APPLICATIONS  
IN AFRICA



PROF. CONGDUC PHAM  
[HTTP://WWW.UNIV-PAU.FR/~CPHAM](http://www.univ-pau.fr/~cpham)  
UNIVERSITÉ DE PAU, FRANCE



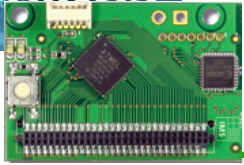

# WAZIUP: LOW-COST IOT



[ABOUT »](#) [TECHNOLOGIES »](#) [COMMUNITY](#) [NEWS & EVENT »](#) [DOWNLOADS](#) [DEV KIT](#) [FAQ](#) [CONTACT](#)

  
HORIZON 2020

AFFORDABLE  
**TECHNOLOGIES**  
TO  
**EMPOWER**  
RURAL ECONOMIES

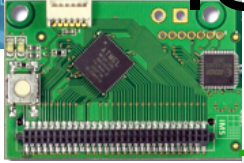

# IoT IN DEVELOPING COUNTRIES AND RURAL AREAS

- ❑ Developing countries/rural areas are still far from being ready to enjoy the smallest benefit of IoT
  - ❑ lack of infrastructure
  - ❑ high cost of hardware
  - ❑ complexity in deployment
  - ❑ lack of technological eco-system and background
- ❑ **to deploy IoT in developing countries, it is necessary to target three major issues**
  - ❑ **reduce cost of infrastructures, hardware and services**
  - ❑ **limit dependancy to proprietary infrastructures and provide local interaction models**
  - ❑ **target technology appropriation, push for local business models**

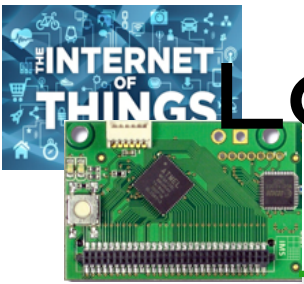

# LOW-POWER & LONG-RANGE RADIO TECHNOLOGIES



## Energy-Range dilemma

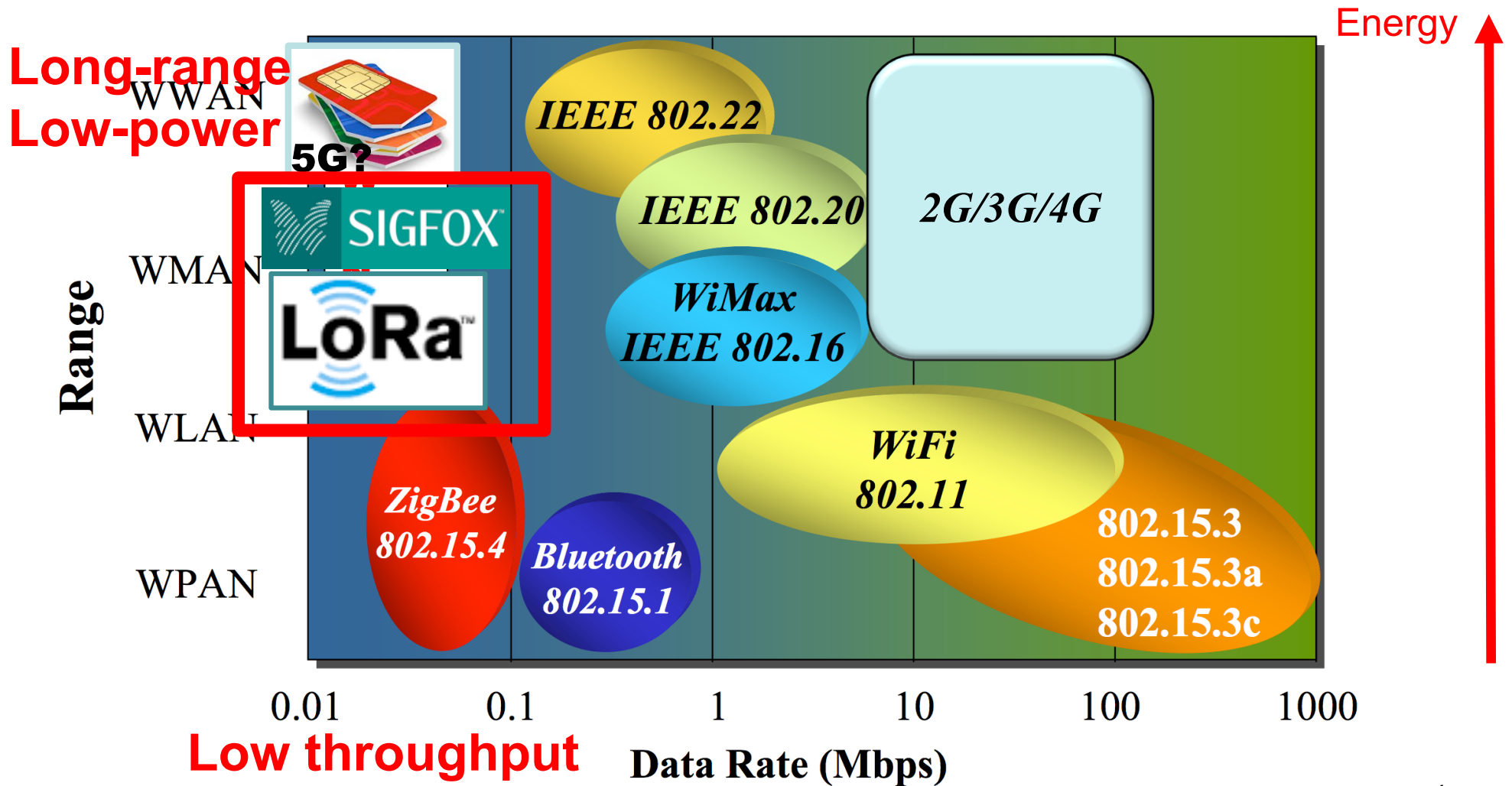

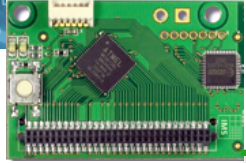

# LOW-COST IOT DEVICES

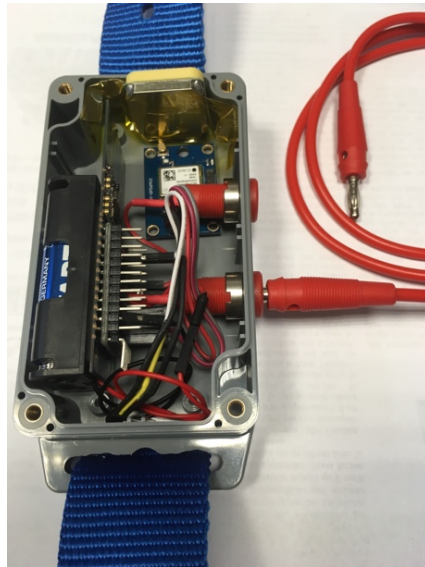



# LARGE ECOSYSTEM, STILL GROWING...



Arduino Pro Mini

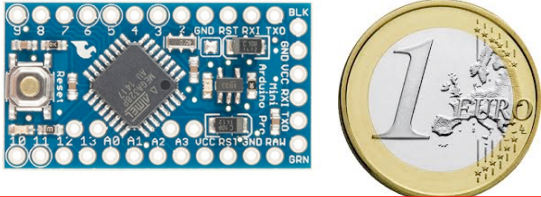

LoPy

<http://blog.atmel.com/2015/12/16/rewind-50-of-the-best-boards-from-2015/>

<http://blog.atmel.com/2015/04/09/25-dev-boards-to-help-you-get-started-on-your-next-iot-project/>



Theairboard



Expressif ESP32

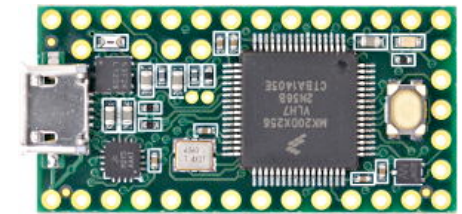

Teensy 3.2

STM32 Nucleo-32

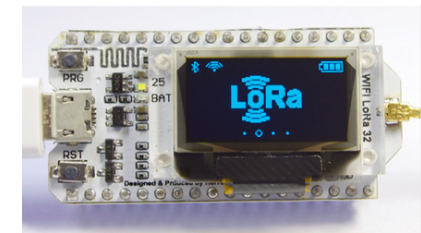
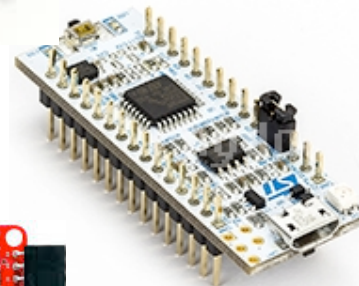

Heltec ESP32 + OLED

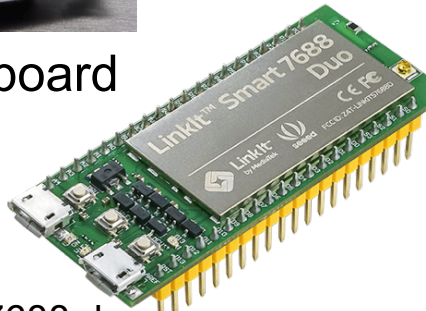

LinkIt Smart7688 duo

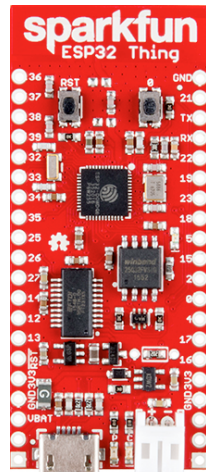

Sparkfun ESP32 Thing



Tessel

SodaqOnev2



Adafruit Feather



Tinyduino

# WAZIUP PROVIDES SW/HW BUILDING BLOCKS INTEGRATION



ARDUINO UNO

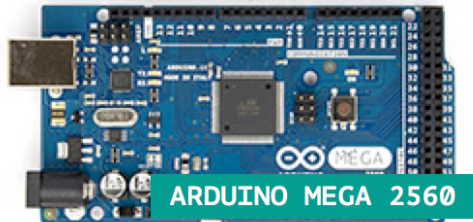

ARDUINO MEGA 2560

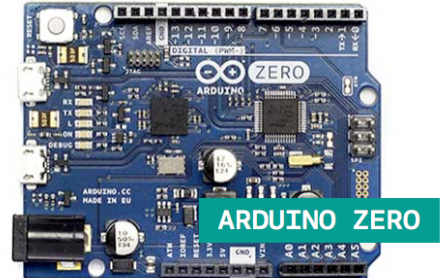

ARDUINO ZERO

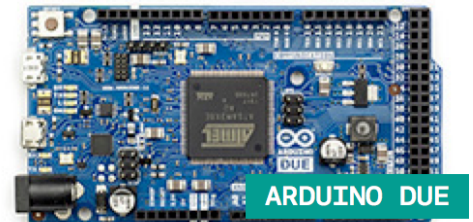

ARDUINO DUE

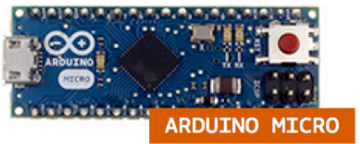

ARDUINO MICRO



ARDUINO PRO MINI

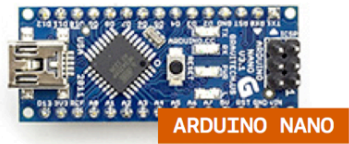

ARDUINO NANO



Ideetron Nexus



TeensyLC/3.1/3.2

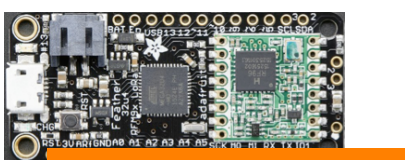

Adafruit Feather 32u4/M0



Expressif ESP8266/ESP32

More to come...



LoRa radios that our library already supports



HopeRF RFM92W/95W

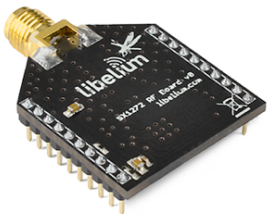

Libelium LoRa



Modtronix inAir9/9B

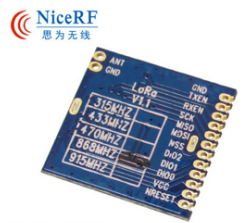

LoRa1276 NiceRF LoRa1276

Long-Range communication library

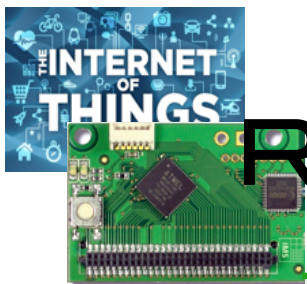

# READY-TO-USE TEMPLATES



Moisture/  
Temperature of  
storage areas



10-15kms



Physical  
sensor



Physical  
sensor



Physical  
sensor

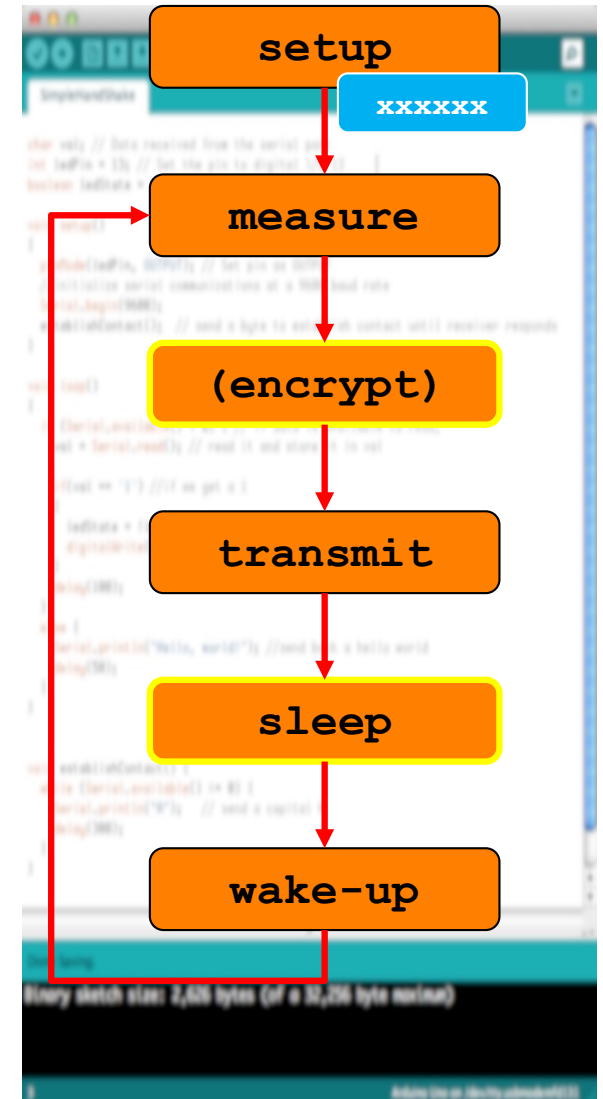
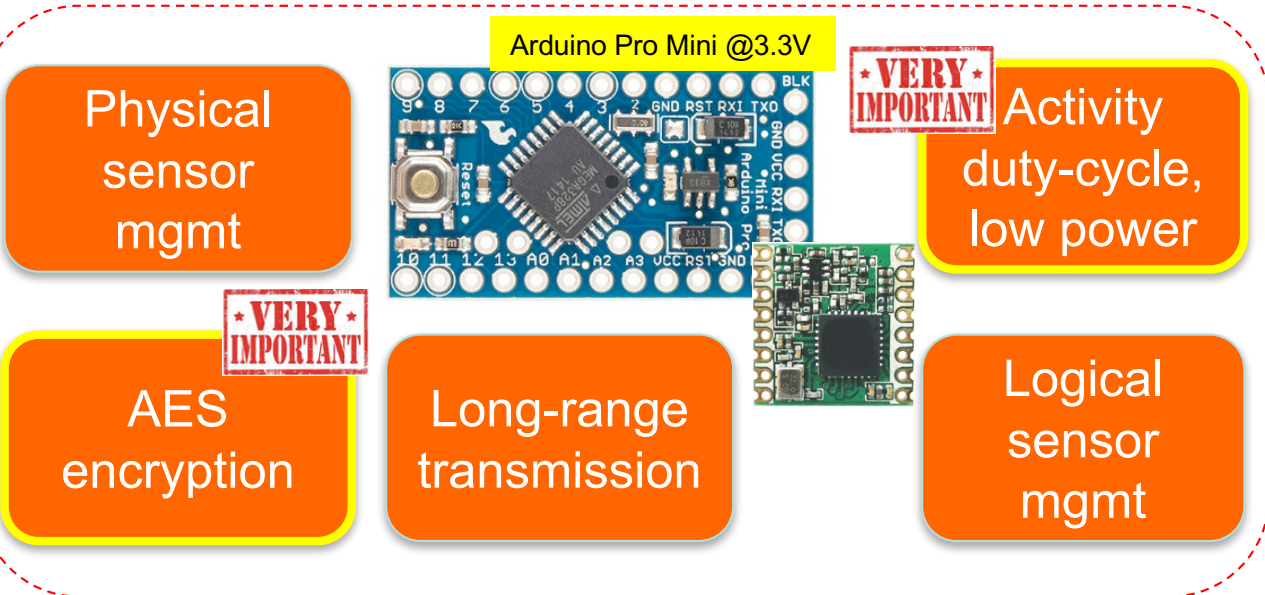
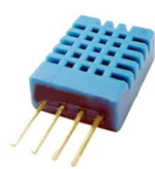





# LOW-POWER FOR LONGER LIFETIME!

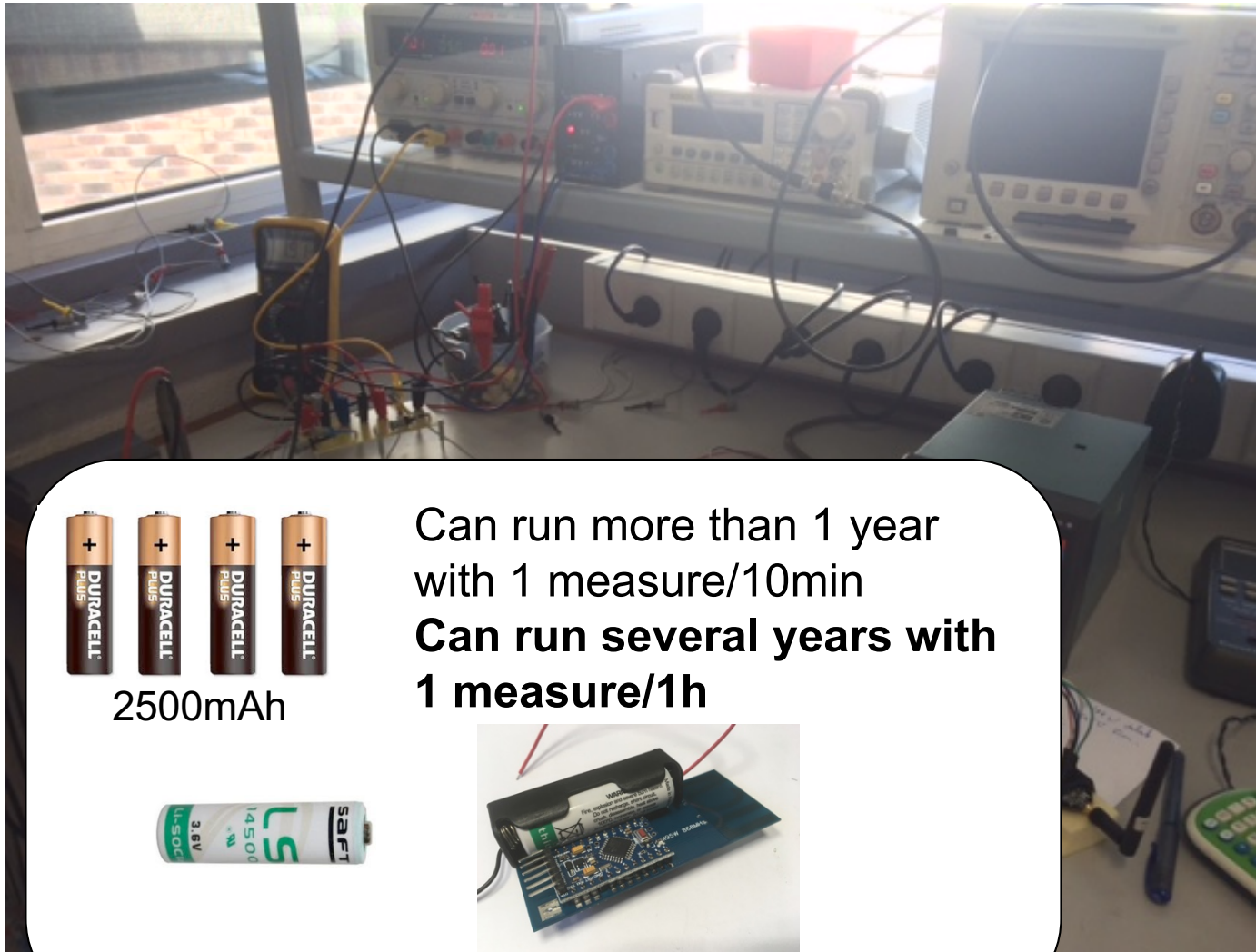

2500mAh

Can run more than 1 year  
with 1 measure/10min  
**Can run several years with  
1 measure/1h**

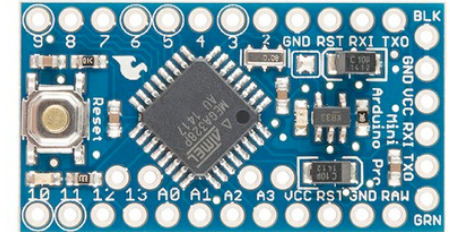

Wakes-up every  
10min, take a  
measure (temp) and  
send to GW

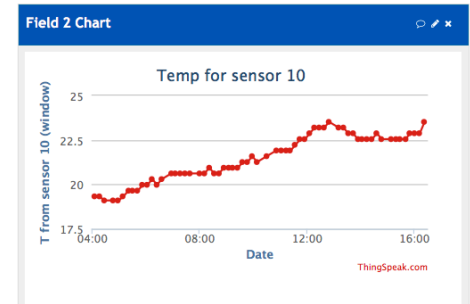

**5 $\mu$ A in deep sleep  
mode, about  
40mA when active  
and sending!**

# A SIMPLE TEMPERATURE SENSOR EXAMPLE

Arduino Pro Mini @3.3V

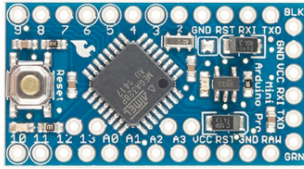

Modtronix inAir9



TMP36

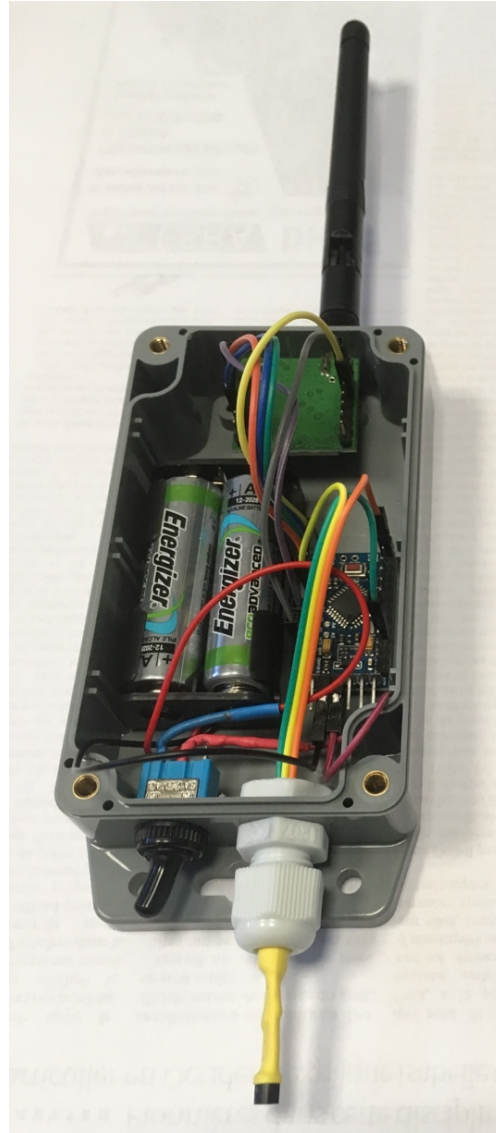

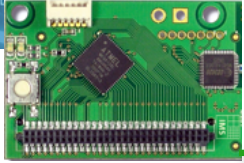

# LOW-COST INTEGRATION

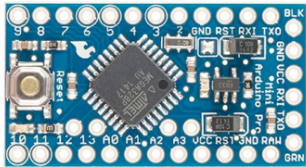

1.5€

[https://github.com/FabienFerrero/UCA\\_Board](https://github.com/FabienFerrero/UCA_Board)

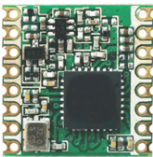

5€

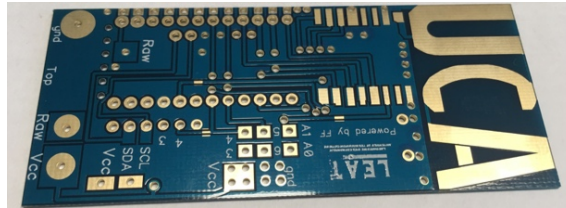

1€

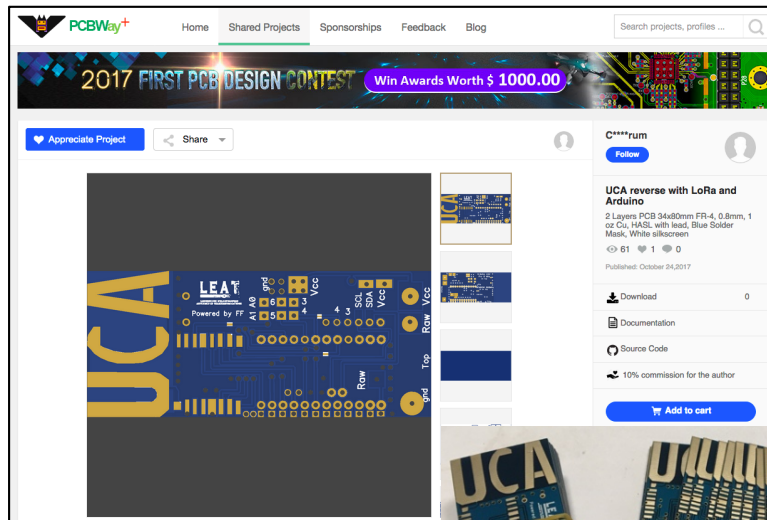
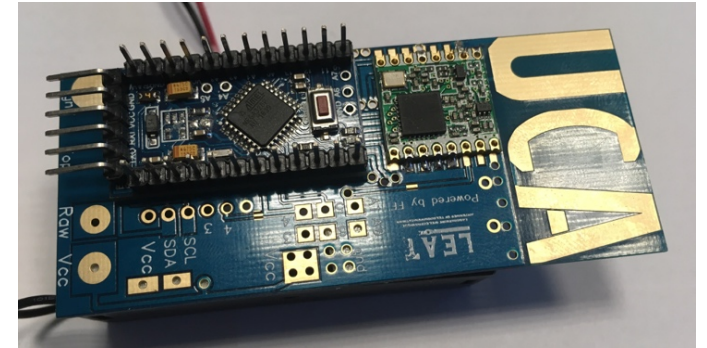

1-click order

Less than 10€/device

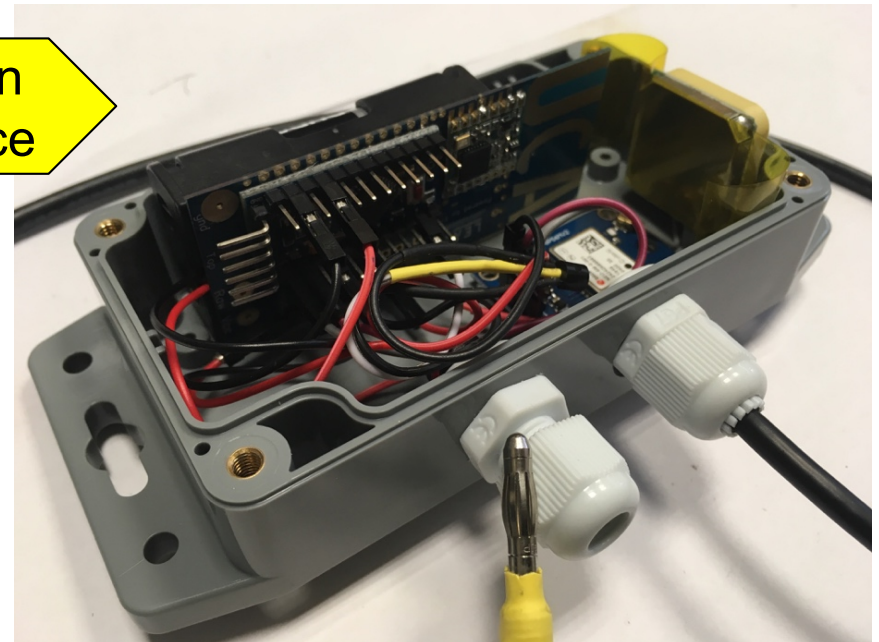
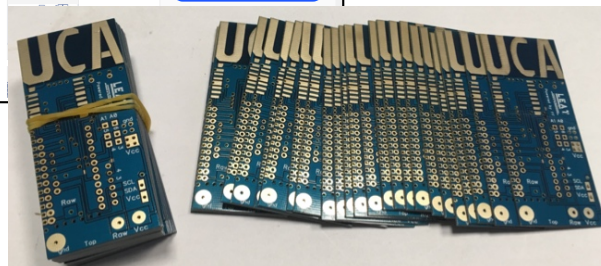

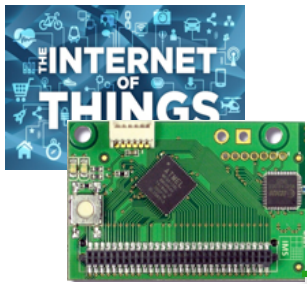

# GENERIC SENSING IOT DEVICE VS HIGHLY SPECIALIZED



- ❑ Build low-cost, low-power, **long-range** enabled generic platform
- ❑ Methodology for low-cost platform design
- ❑ Technology transfers to user communities, economic actors, stakeholders,...

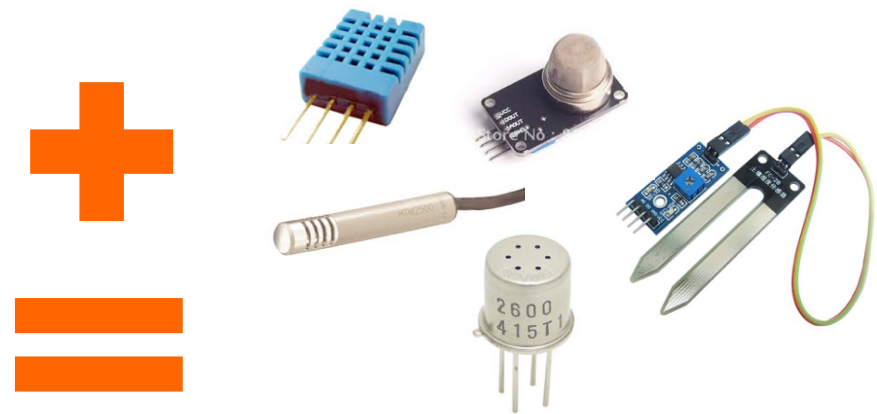
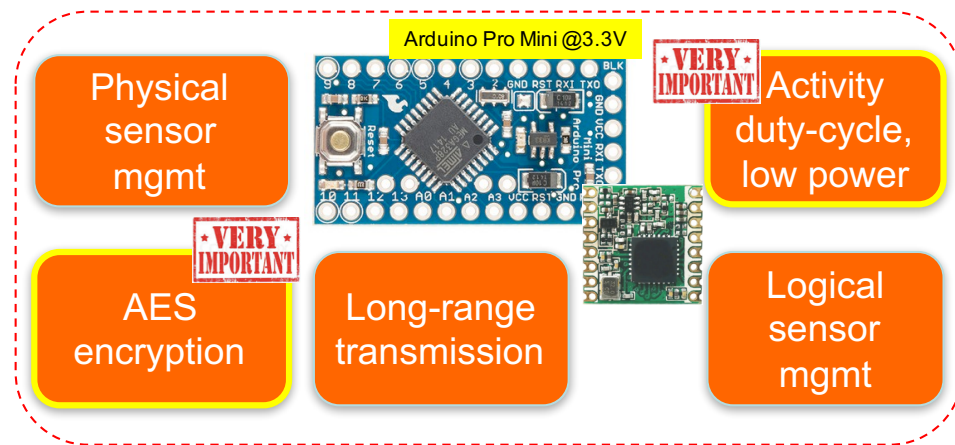

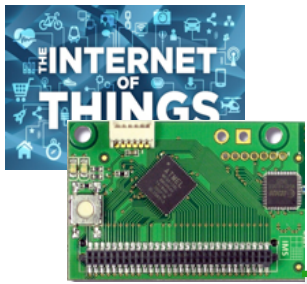

# GENERIC SENSING IOT DEVICE VS HIGHLY SPECIALIZED



- ❑ Build low-cost, low-power, **long-range** enabled generic platform
- ❑ Meet the needs of the market
- ❑ Technical and economic

## Minimum Viable Product

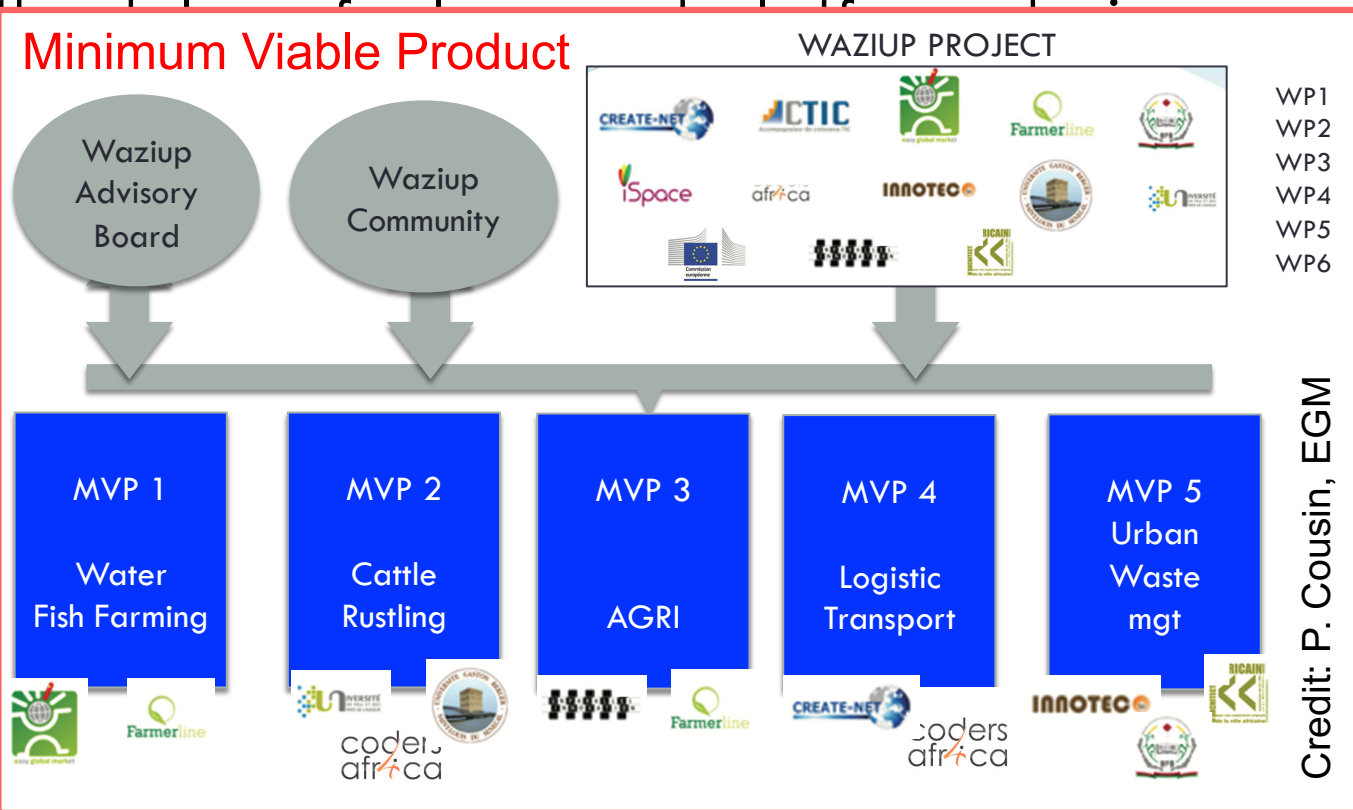

Physical sensor mgmt

**\*VERY IMPORTANT\***

AES encryption

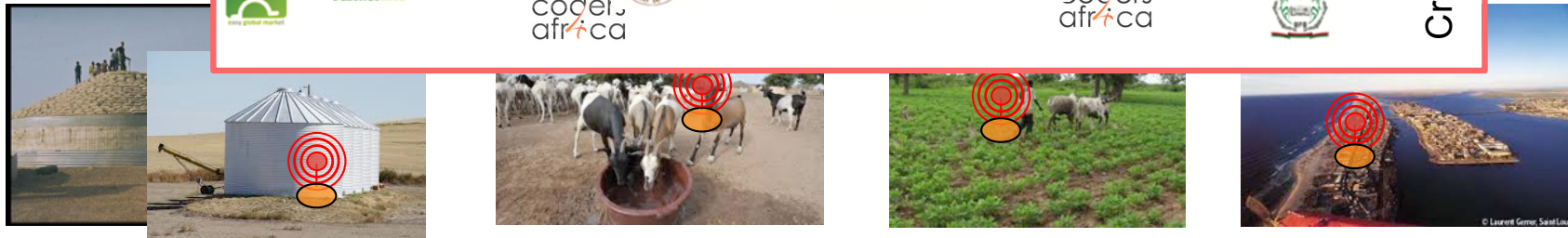
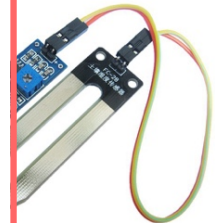



# LOW-COST BUOY FOR FISH FARMING MVP

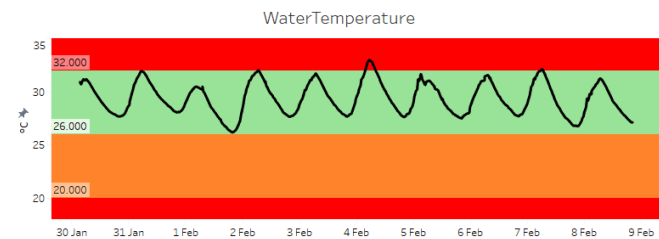
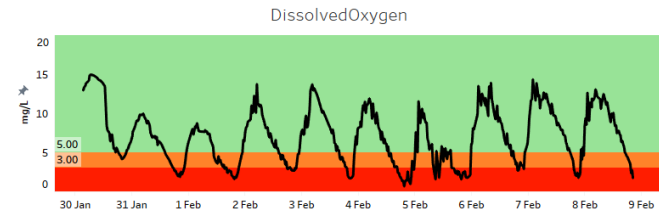
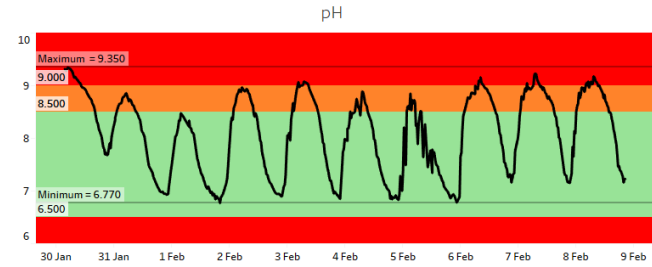

Physical sensor reading

Credit: EGM

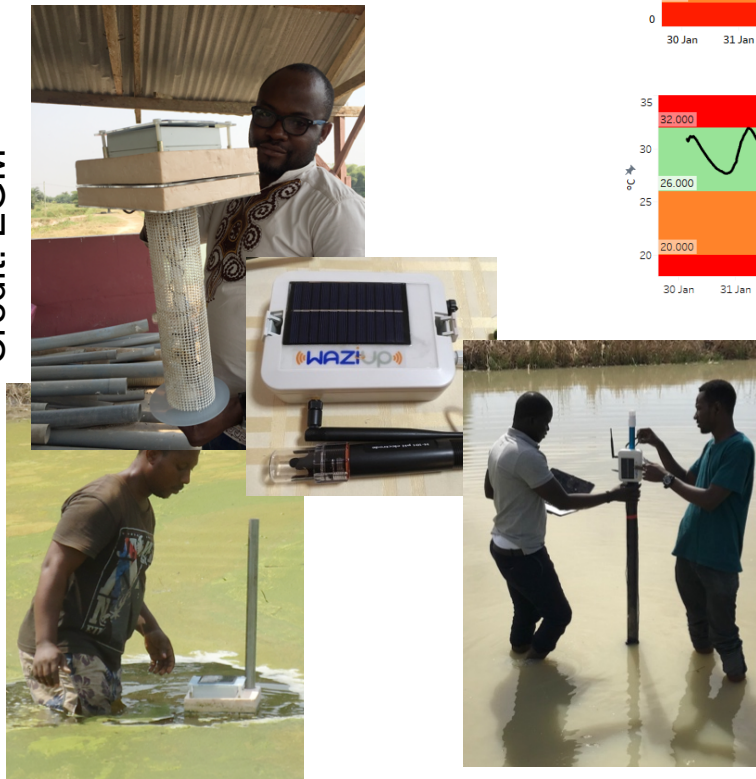

Physical sensor management

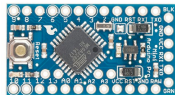

Activity duty-cycle, low power

Security

Long-range transmission

Logical sensor management

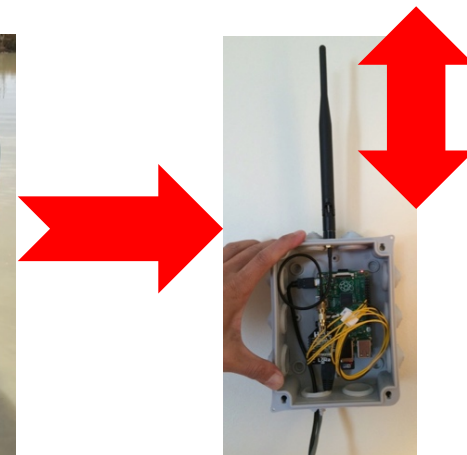

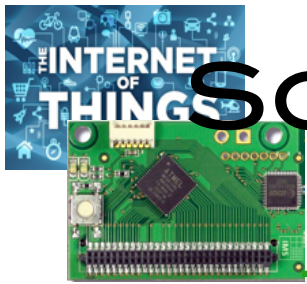

# SOIL HUMIDITY SENSORS FOR AGRI MVP

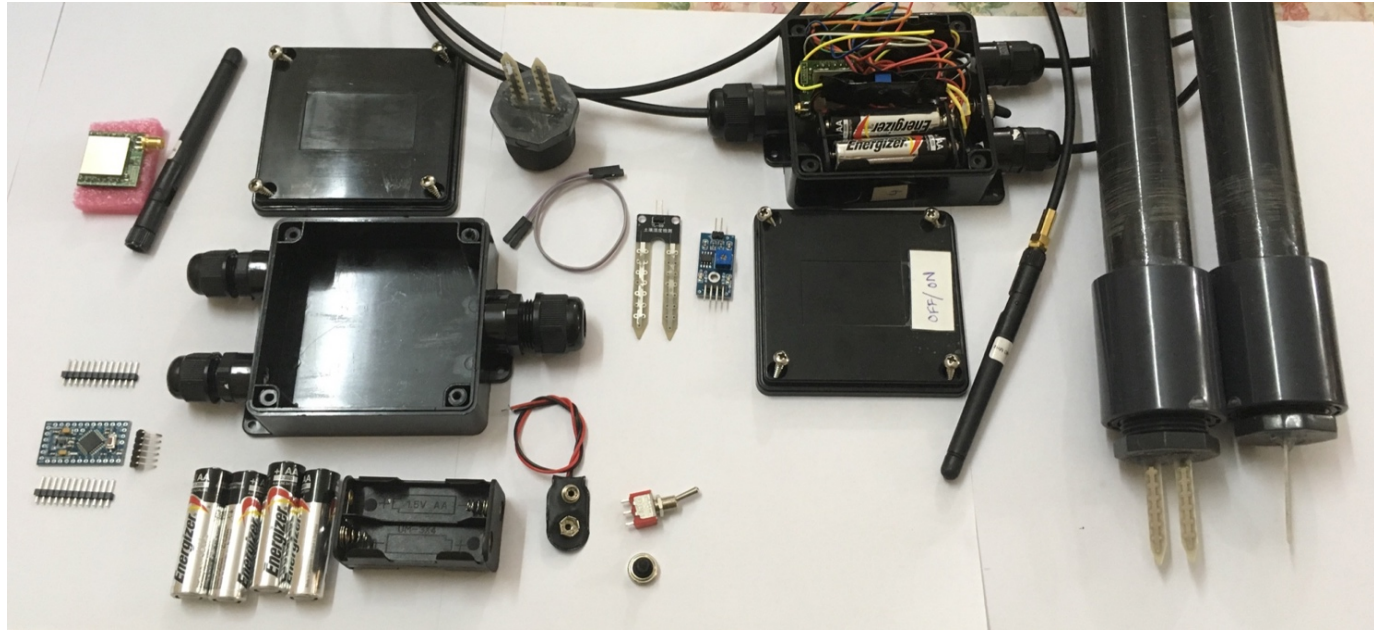

Physical sensor management

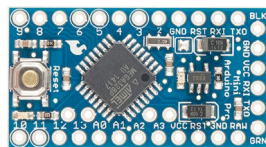

Activity duty-cycle, low power

Security

Long-range transmission

Logical sensor management



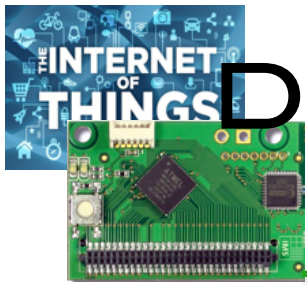

# DEPLOYMENT FOR NESTLÉ'S WATERSENSE PROJECT





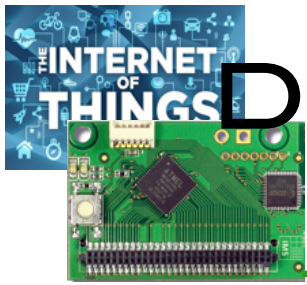

# DEPLOYMENT FOR NESTLÉ'S WATERSENSE PROJECT

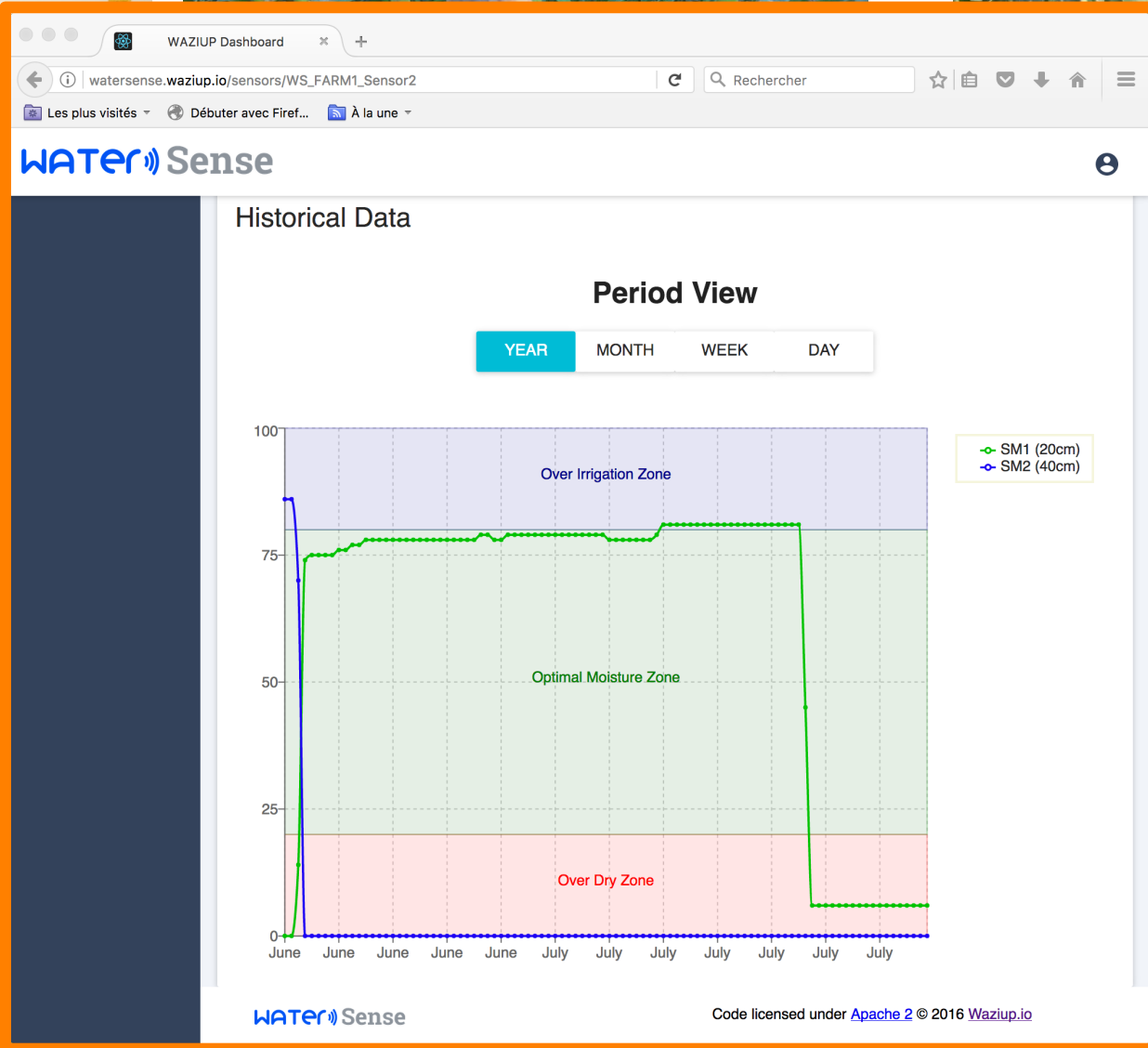



# LOCAL INTEGRATION WITH TECHNOLOGY TRANSFER

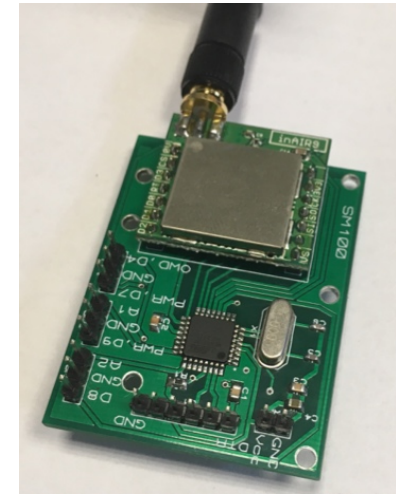
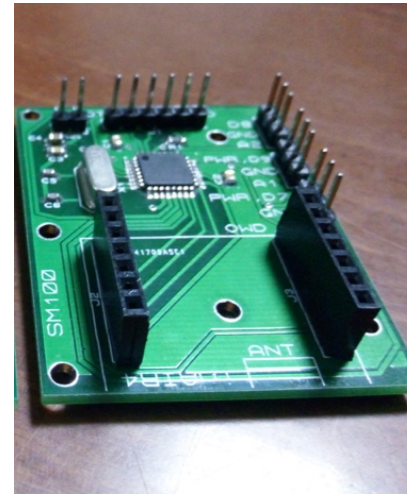
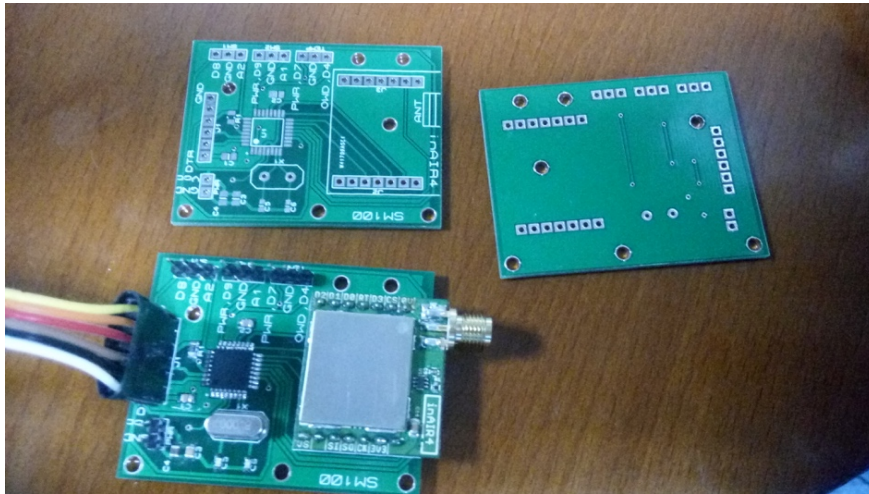

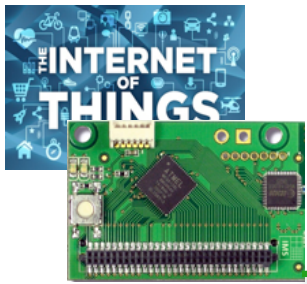

# COLLAR FOR CATTLE RUSTLING MVP

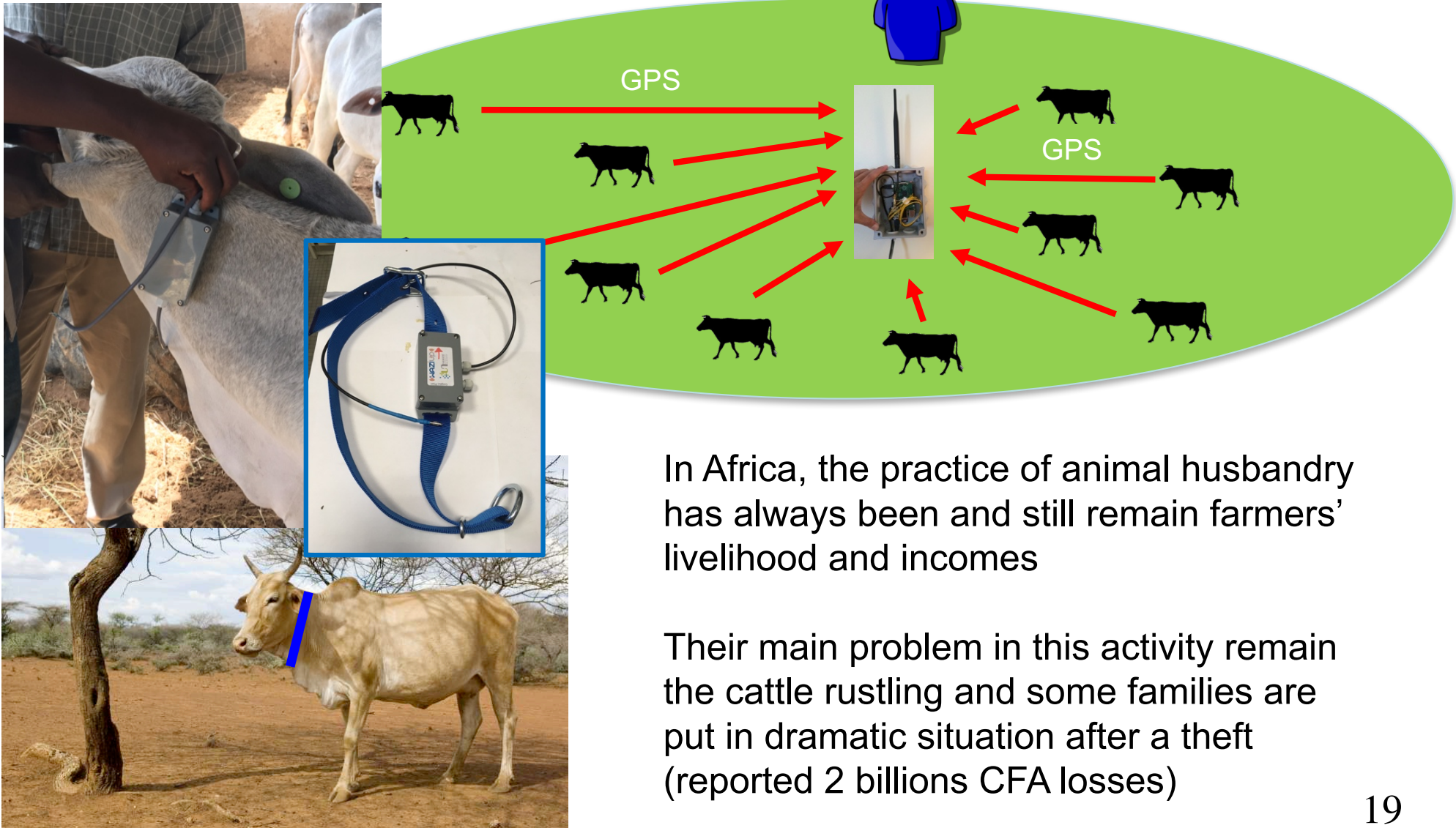

In Africa, the practice of animal husbandry has always been and still remain farmers' livelihood and incomes

Their main problem in this activity remain the cattle rustling and some families are put in dramatic situation after a theft (reported 2 billions CFA losses)

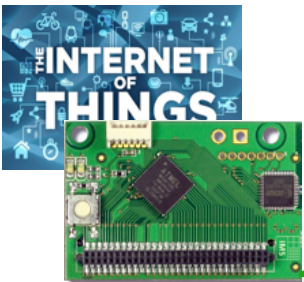

# EASY INTEGRATION AND CUSTOMIZATION

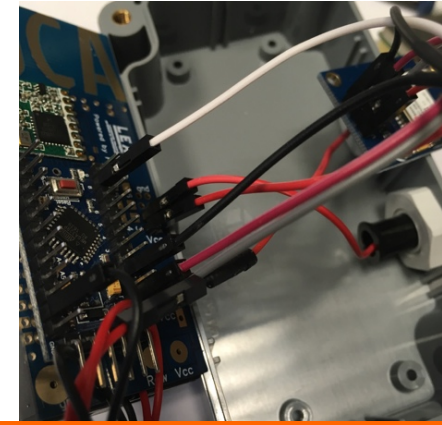
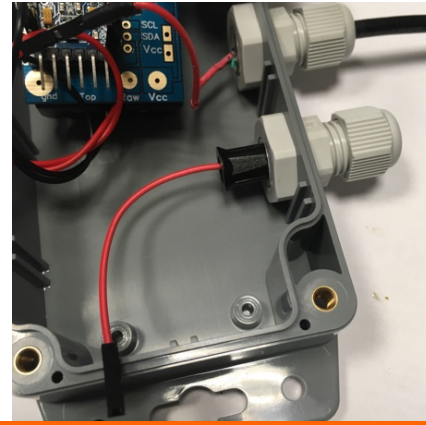
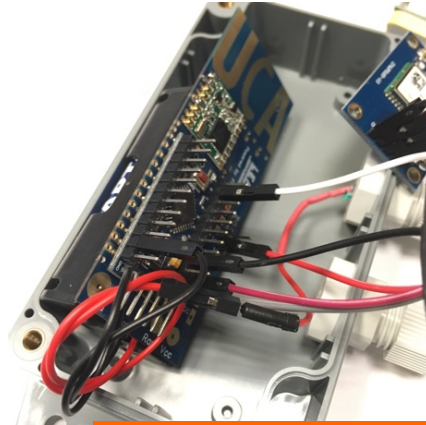
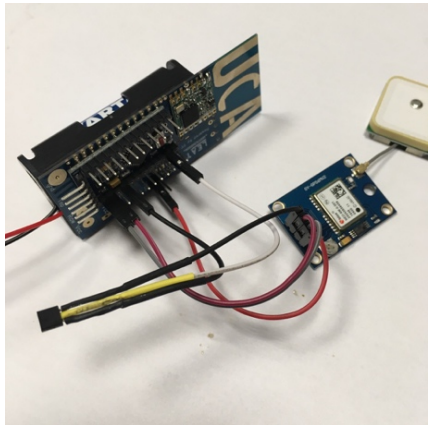

A web interface will display the position of the gateway and those of the remote GPS devices

GPS

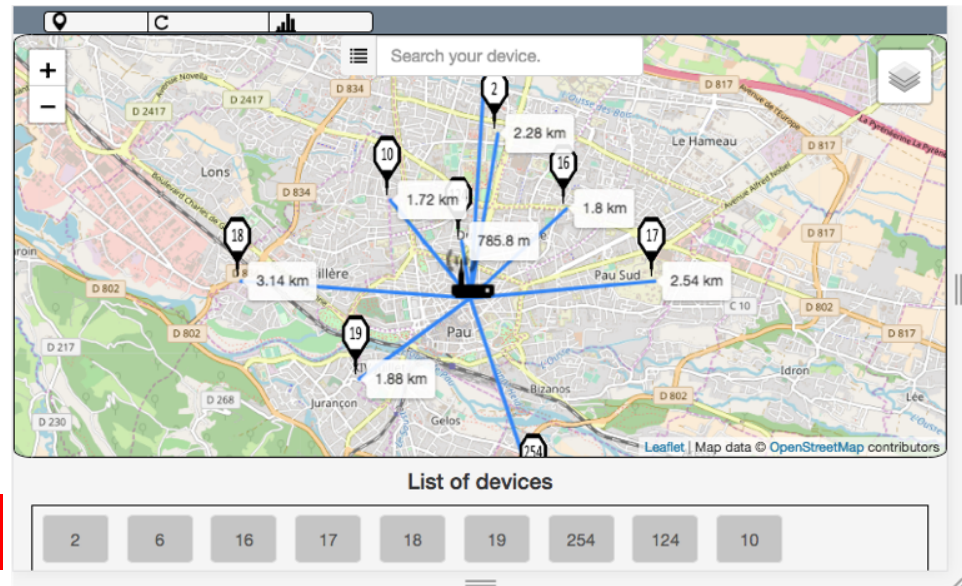
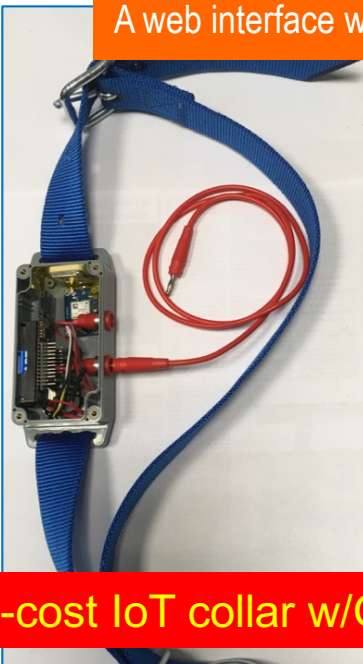
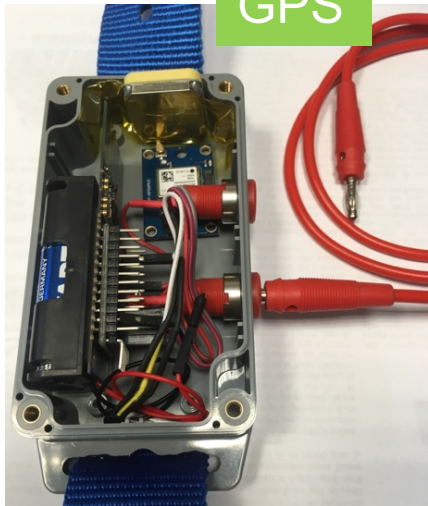

Dedicated tutorial on low-cost IoT collar w/GPS

<https://github.com/CongducPham/tutorials/blob/master/Low-cost-LoRa-Collar.pdf>

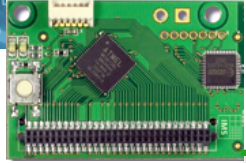

# THE VERSATILE IOT GATEWAY

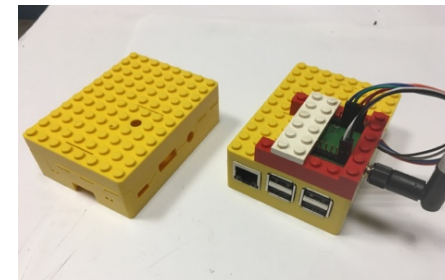
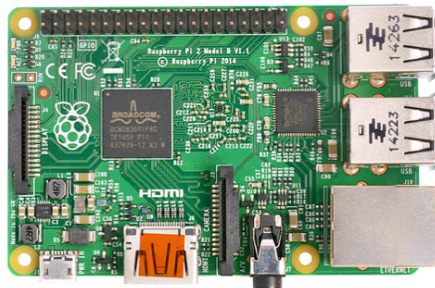

# RASPBERRY-BASED LOW-COST LORA GATEWAY

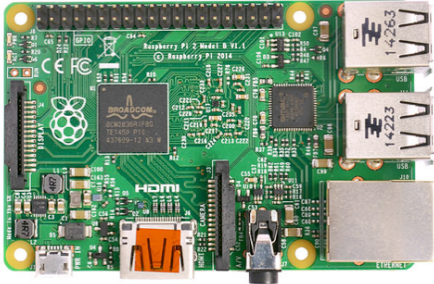

We can use all model of Raspberry. The most important usefull feature is the Ethernet interface for easy Internet connection. Then WiFi and Bluetooth can be added with USB dongles. RPI3 provides built-in Ethernet, WiFi and Bluetooth!

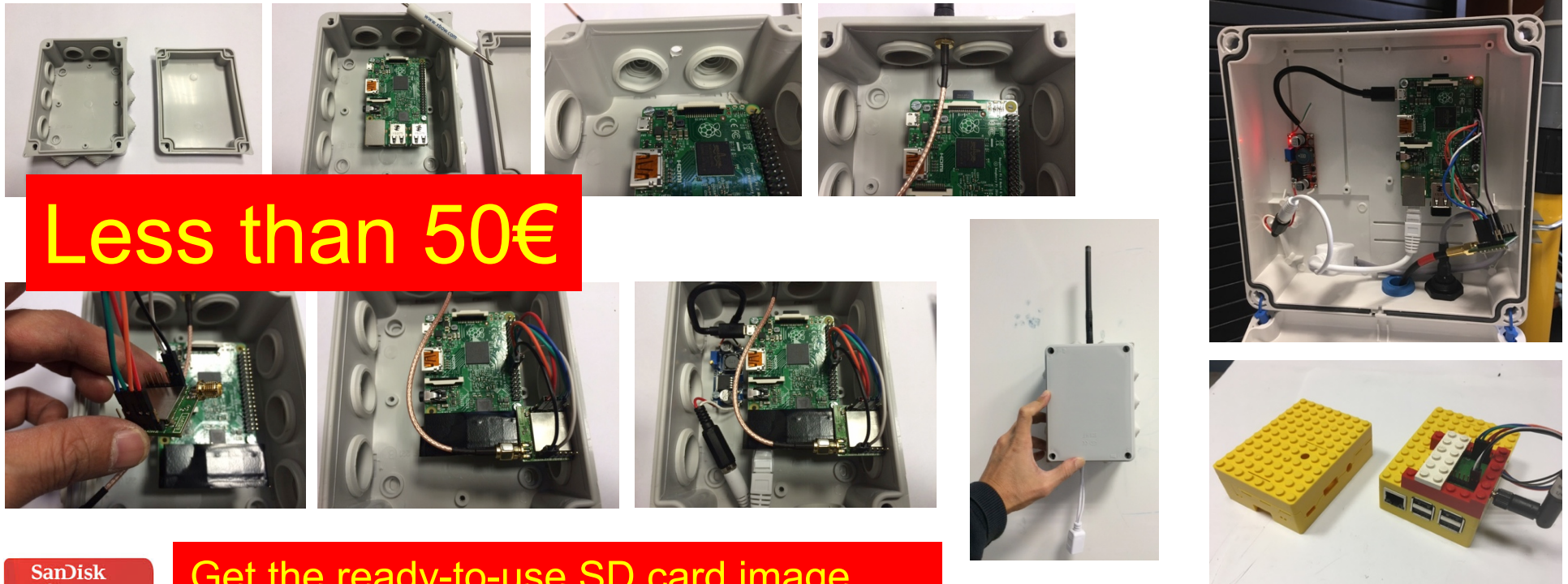

Less than 50€



Get the ready-to-use SD card image

<http://cpham.perso.univ-pau.fr/LORA/WAZIUP/raspberrypi-jessie-WAZIUP-demo.dmg.zip>

# Post-processing stage

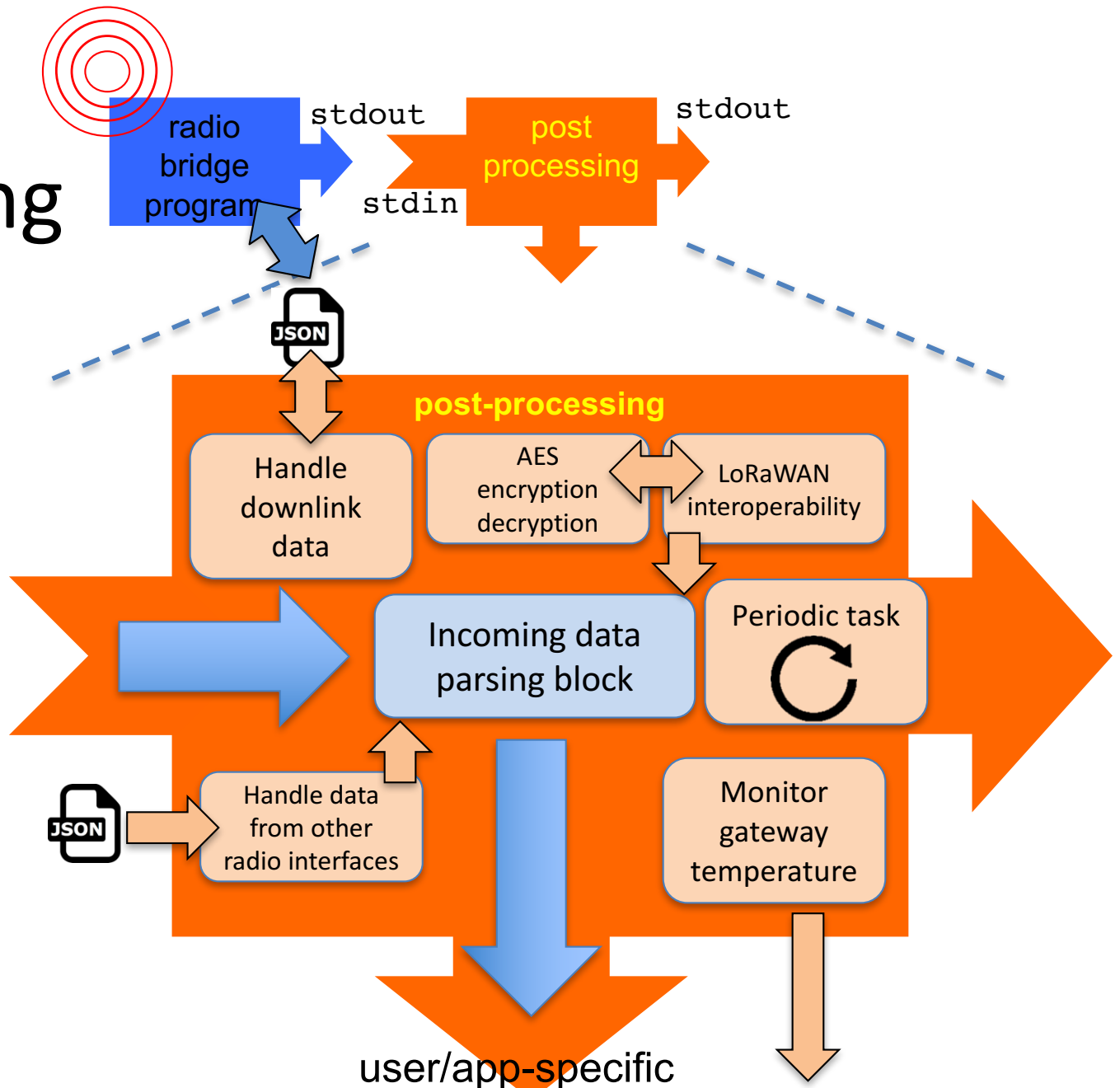

Cloud definition

user/app-specific

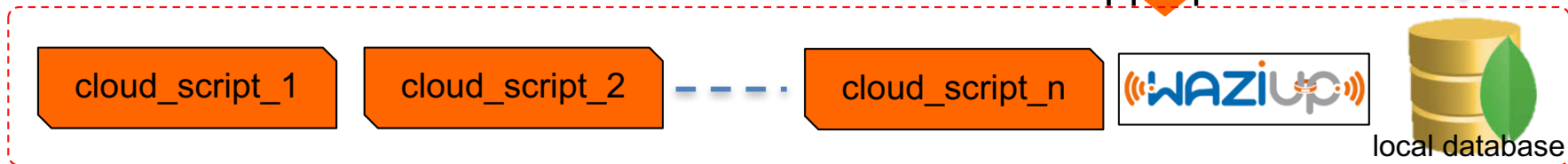



# TEMPLATES FOR VARIOUS CLOUDS

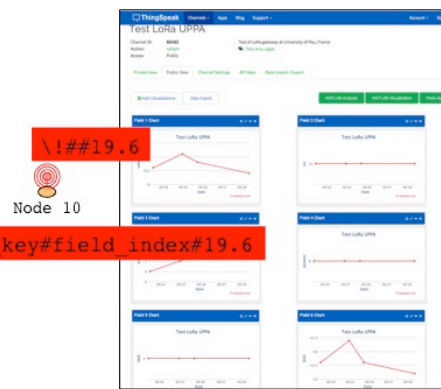
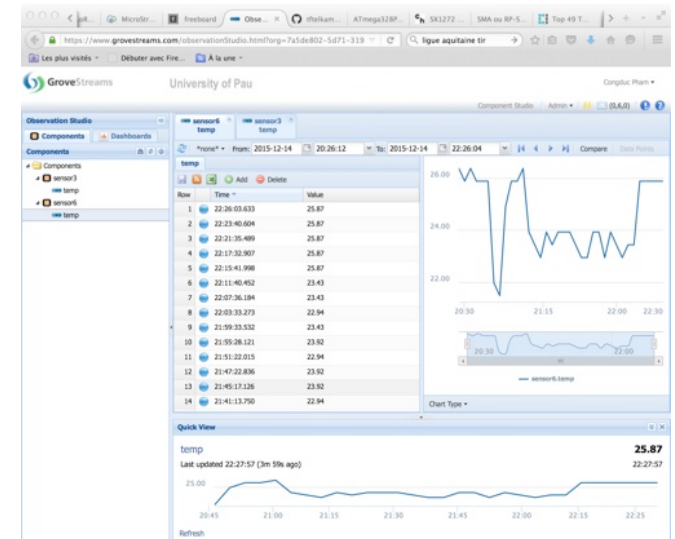
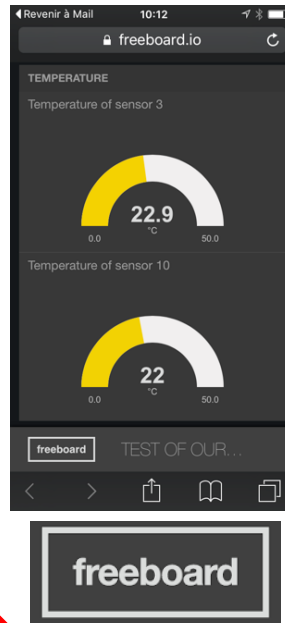
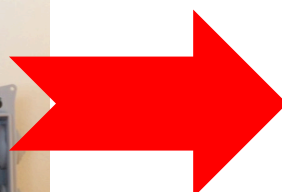
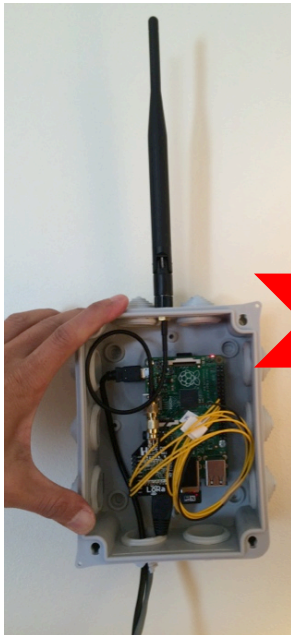

And much more: HTTP, FTP, MQTT, Node-Red...







# STANDALONE GATEWAY

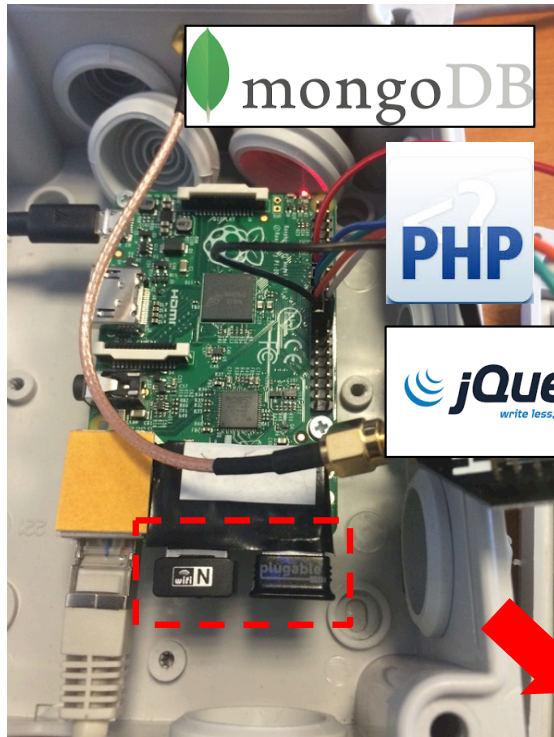

mongoDB



PHP

jQuery  
*write less, do more.*

## Access to the data from MongoDB

export data to csv

Display the 10 last document(s)

Sort by date

Valid

2016-12-15 15:47:58
2016-12-15 15:41:29
2016-12-15 15:36:24
2016-12-15 15:28:32
2016-12-15 15:24:50
2016-12-15 16:13:26
2016-12-15 15:03:38
2016-12-15 15:01:52
2016-12-15 14:56:37
2016-12-15 14:51:40

Display data:  RSSI  TC  DEF

Display sources:  node\_3  node\_6  node\_10

Zoom to:  Whole period  Last month  Current month  Last seven days  Current day



Isolated areas



Orange F

Bluetooth\_raspi

```

NODE: 1 DATE: 2016-05-09 08:04:59.807000 DATA: {"lw": 3.29, "th": 22.6, "hu": 50.7}
NODE: 1 DATE: 2016-05-09 08:28:52.993000 DATA: {"lw": 3.29, "th": 22.89, "hu": 50.29}
NODE: 1 DATE: 2016-05-09 08:53:04.317000 DATA: {"lw": 3.29, "th": 23.2, "hu": 50.79}
NODE: 1 DATE: 2016-05-09 09:05:00.997000 DATA: {"lw": 3.29, "th": 23.29, "hu": 51.29}
NODE: 1 DATE: 2016-05-09 09:17:24.482000 DATA: {"lw": 3.29, "th": 23.39, "hu": 51.7}
NODE: 1 DATE: 2016-05-09 09:41:27.437000 DATA: {"lw": 3.29, "th": 23.6, "hu": 52.0}
NODE: 1 DATE: 2016-05-09 10:05:39.032000 DATA: {"lw": 3.29, "th": 23.79, "hu": 51.5}
NODE: 1 DATE: 2016-05-09 10:17:45.186000 DATA: {"lw": 3.29, "th": 23.79, "hu": 50.79}
NODE: 1 DATE: 2016-05-09 10:29:24.285000 DATA: {"lw": 3.29, "th": 23.79, "hu": 50.79}
NODE: 1 DATE: 2016-05-09 10:53:09.347000 DATA: {"lw": 3.29, "th": 23.79, "hu": 51.9}
NODE: 1 DATE: 2016-05-09 11:17:02.953000 DATA: {"lw": 3.29, "th": 23.5, "hu": 50.79}
NODE: 1 DATE: 2016-05-09 11:52:53.334000 DATA: {"lw": 3.29, "th": 23.29, "hu": 50.7}
NODE: 1 DATE: 2016-05-09 12:04:32.437000 DATA: {"lw": 3.29, "th": 23.5, "hu": 50.29}
NODE: 1 DATE: 2016-05-09 12:16:56.116000 DATA: {"lw": 3.29, "th": 23.6, "hu": 50.29}
    
```

Display data    Retrieve data in a csv file

Orange F

Bluetooth\_raspi

**NODES PREFERENCES**

1 check to retrieve its data

8 check to retrieve its data

**DATES PREFERENCES**

Pick a begin date  
Retrieve data since 09-05-2016

Pick an end date  
Retrieve data until 17-05-2016

Display data    Retrieve data in a csv file

Orange F

Bluetooth\_raspi

Creating csv file with the data received...  
File 17-05-2016\_10h39m36s.csv created and saved in the folder /storage/emulated/0/Raspberry\_local\_data

Display data    Retrieve data in a csv file



# CUSTOMIZING/EXTENDING YOUR GATEWAY



- ❑ The flexible gateway architecture offers high versatility by customization
- ❑ There are 3 options for customization
- ❑ **The geek way**
  - ❑ Modify/extend post-processing script
- ❑ **The "smarter" way**
  - ❑ Add "cloud" scripts
    - On packet reception
  - ❑ Add periodic tasks
    - Independant from packet reception

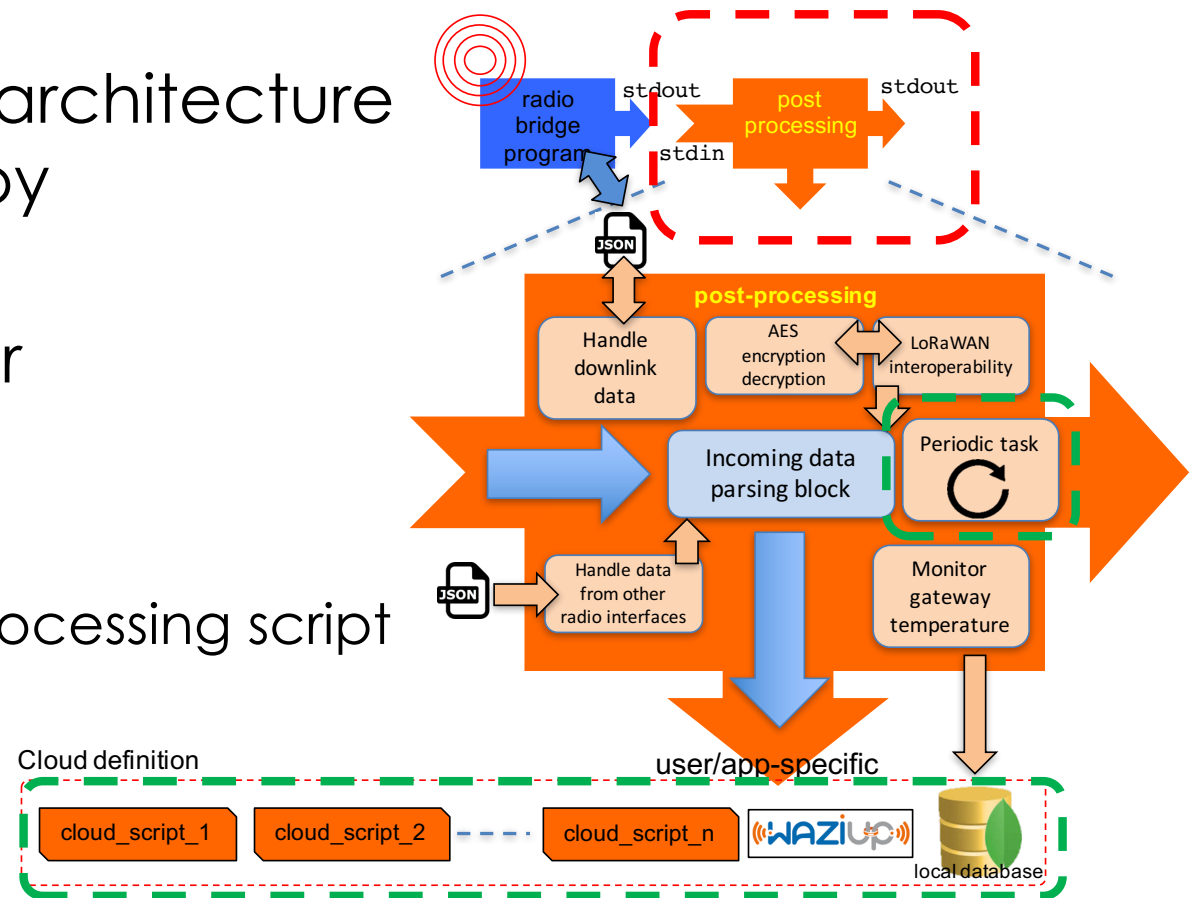



# THE NODE-RED ENABLED GATEWAY



- Messages received on the gateway can be injected into a Node-Red flow, allowing complex data processing to be defined

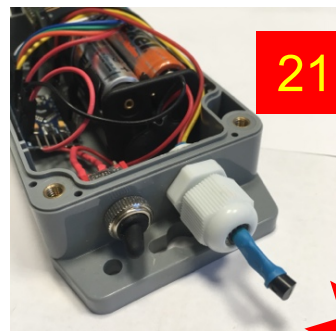

21.65

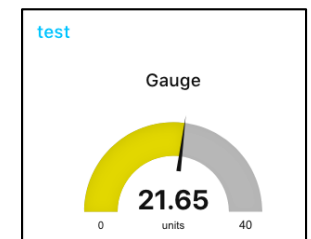

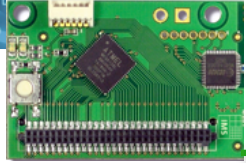

# RESEARCH ACTIVITIES

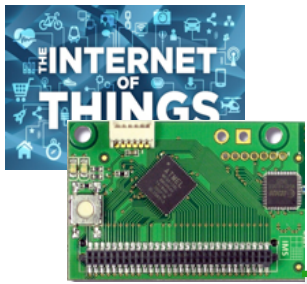

# 2-HOP LoRa



- Provides 2-hop LoRa to solve some connectivity issues in real-world deployment scenario

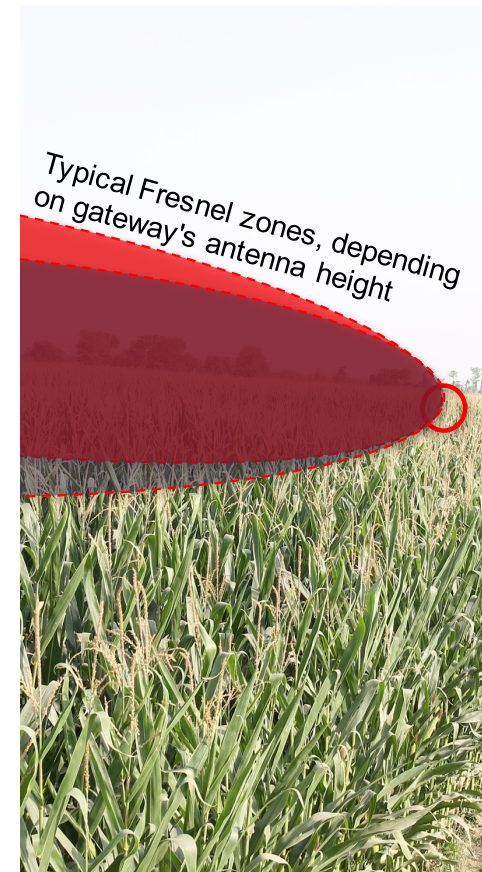
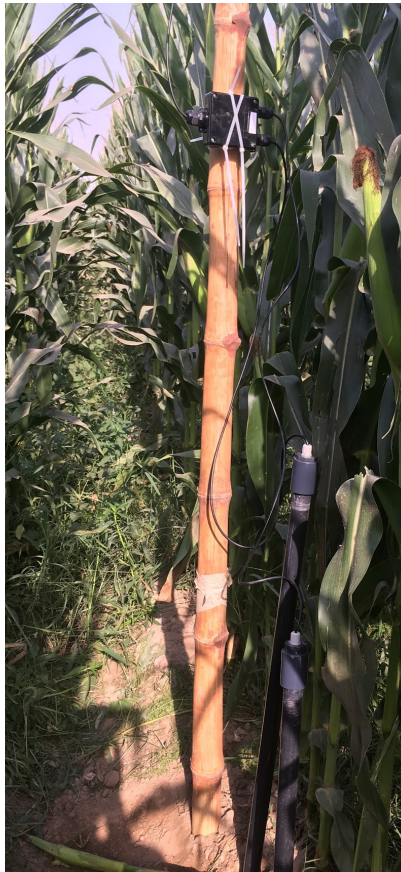

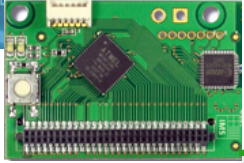

# 2-HOP LORA APPROACH

- Objective is to have a **smart, transparent** relay node that can be inserted at anytime between end-devices and gateway

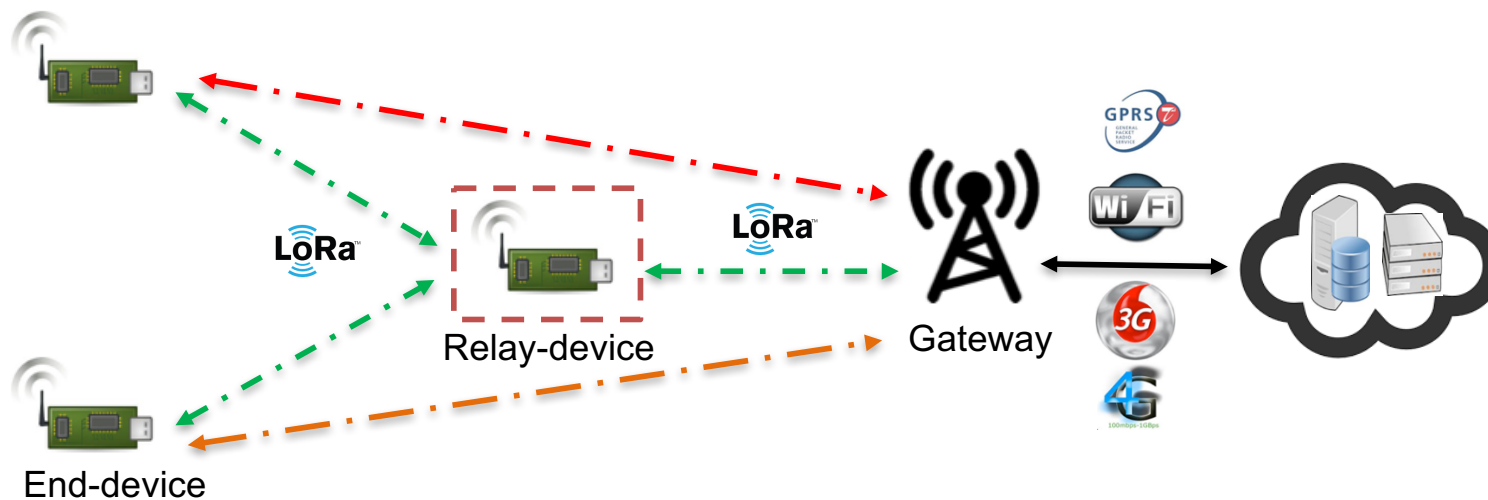

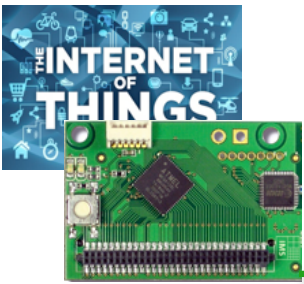

# SMART RELAY DEVICE LEARNING ON-THE-FLY



- On-the-fly learning of incoming traffic from end-devices: **the observation phase**

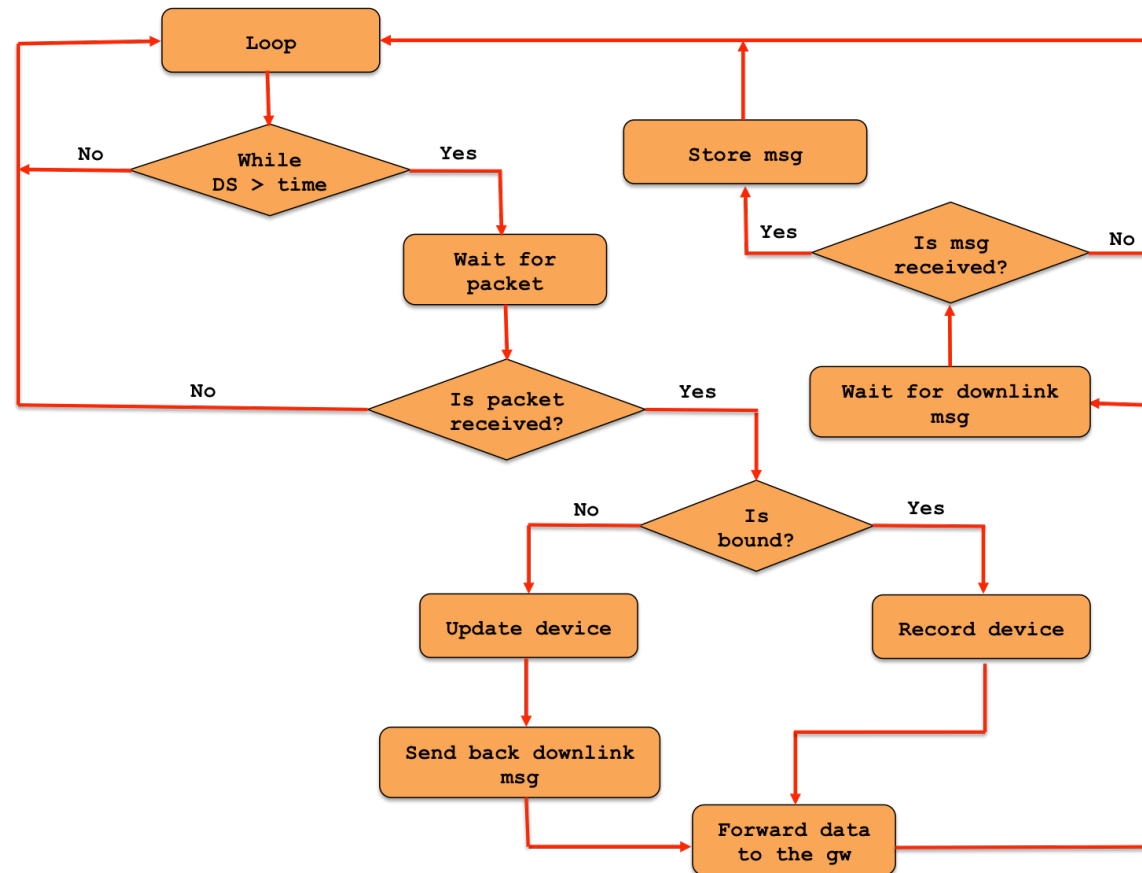

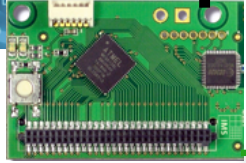

# ROBUST CHANNEL ACCESS MECHANISMS



- With densier LoRa networks and more heterogeneous traffic (traditional+image sensors) it is necessary to provide a more robust channel access mechanism
- Objectives are to reduce packet collisions, thus reducing delivery latency, and reduce power consumption due to unsuccessful transmissions

C. Pham, "Investigating and Experimenting CSMA Channel Access Mechanisms for LoRa IoT Networks", IEEE WCNC'2018.

C. Pham, "Robust CSMA for Long-Range LoRa Transmissions with Image Sensing Devices", IEEE WD'2018.





# CSMA-BASED DERIVED FROM 802.11

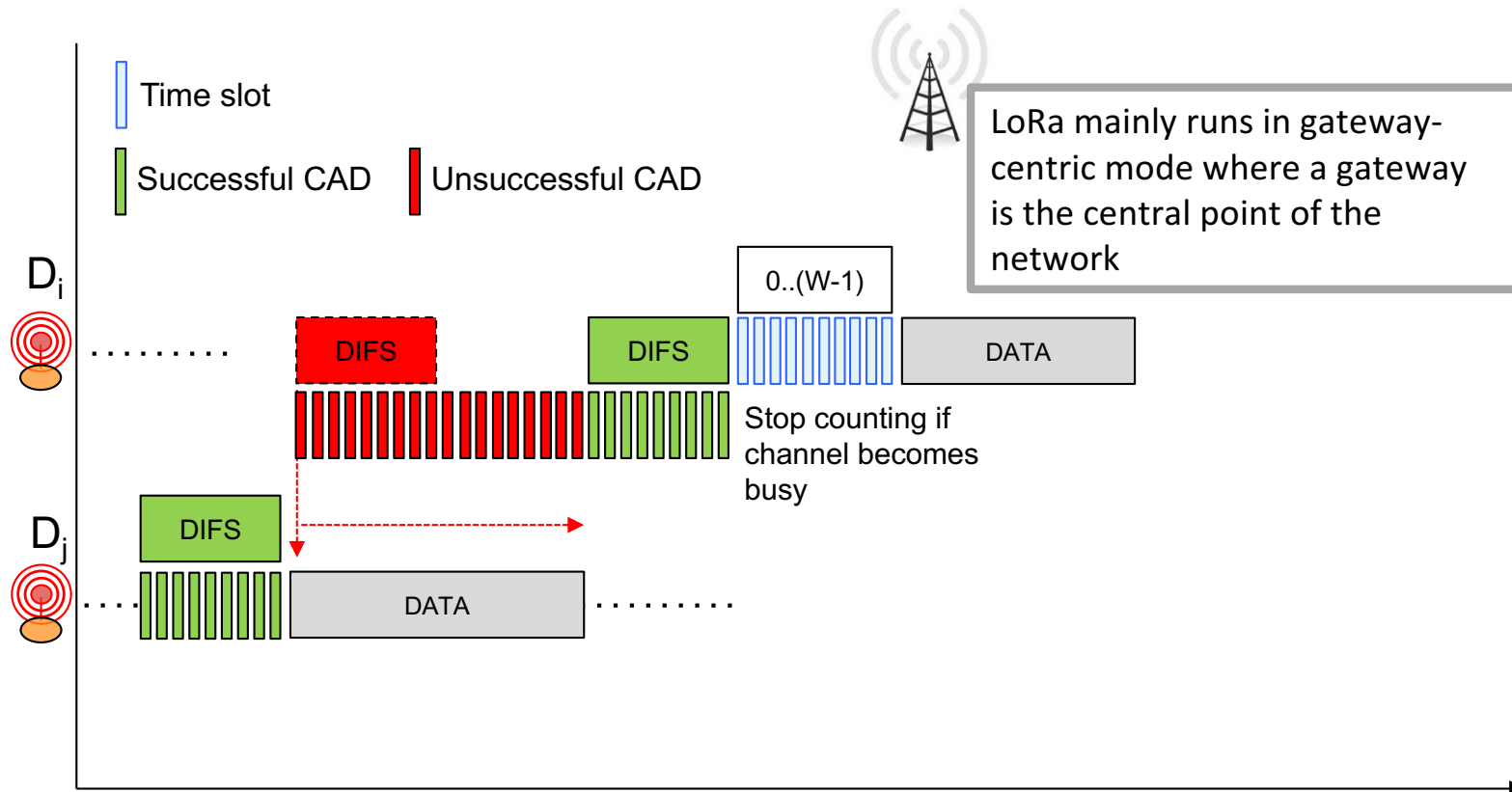



# CSMA-BASED ADAPTED TO LONGER MSG

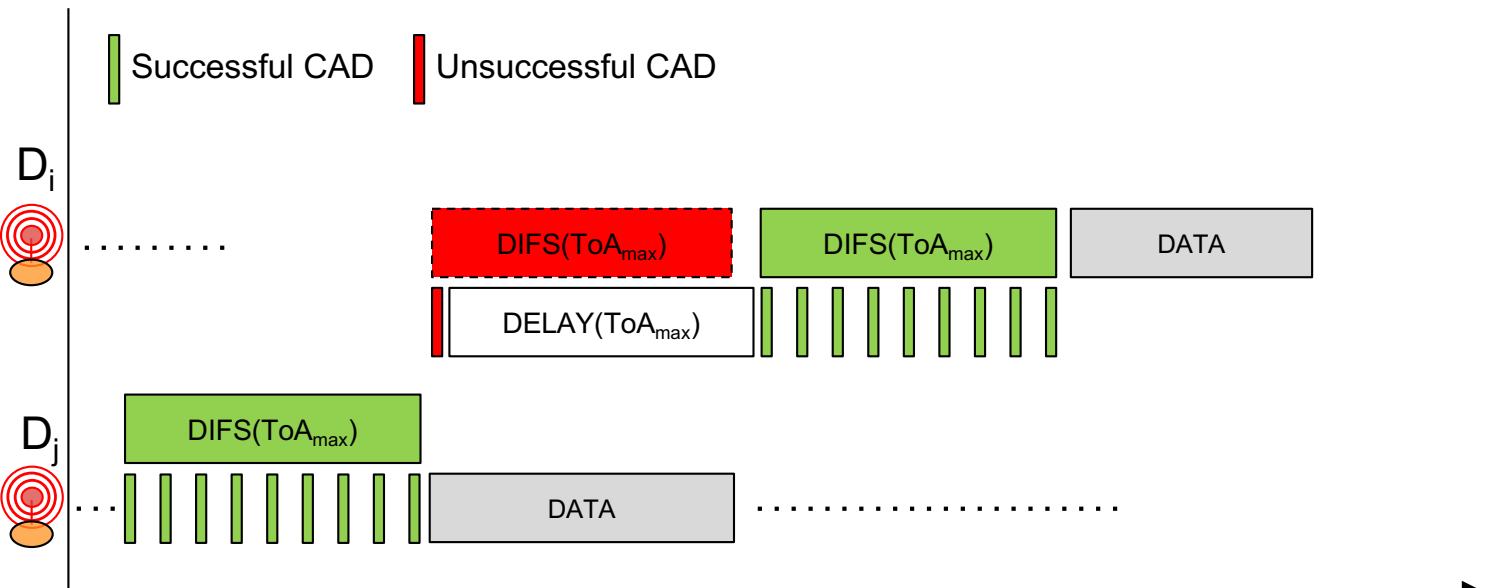
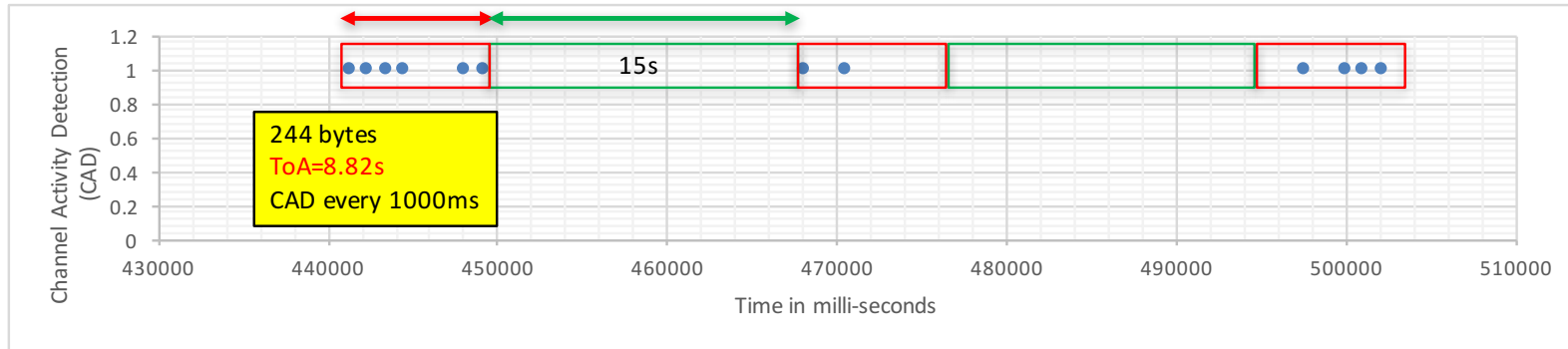

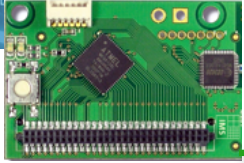

# QUALITY OF SERVICE

- ❑ Regulations stipulate that **radio activity duty-cycle should be enforced at devices.**
- ❑ LoRaWAN specification from LoRa Alliance is a first attempt to standardize LoRa networks but **no issues on quality of service.**
- ❑ Proposition of a Long-range Activity Sharing (LAS) mechanism when running under duty-cycle regulations
- ❑ Allow a device to be able to send critical data without having to wait for the next cycle

C. Pham, "Deploying a Pool of Long-Range Wireless Image Sensor with Shared Activity Time". Proceedings of the 11th IEEE WiMob'2015, October 19-21, 2015, Abu Dhabi, UAE.

C. Pham, "Towards Quality of Service for Long-range IoT in Unlicensed Radio Spectrum". IEEE Wireless Days (WD'2016), Toulouse, France, March 2016.

C. Pham, "QoS for Long-Range Wireless Sensors under Duty-Cycle Regulations with Shared Activity Time Usage". ACM Transactions on Sensor Networks, Vol. 12(4), 2016.

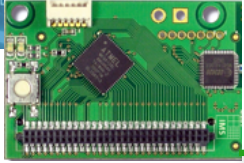

# LONG-RANGE ACTIVITY SHARING (LAS)

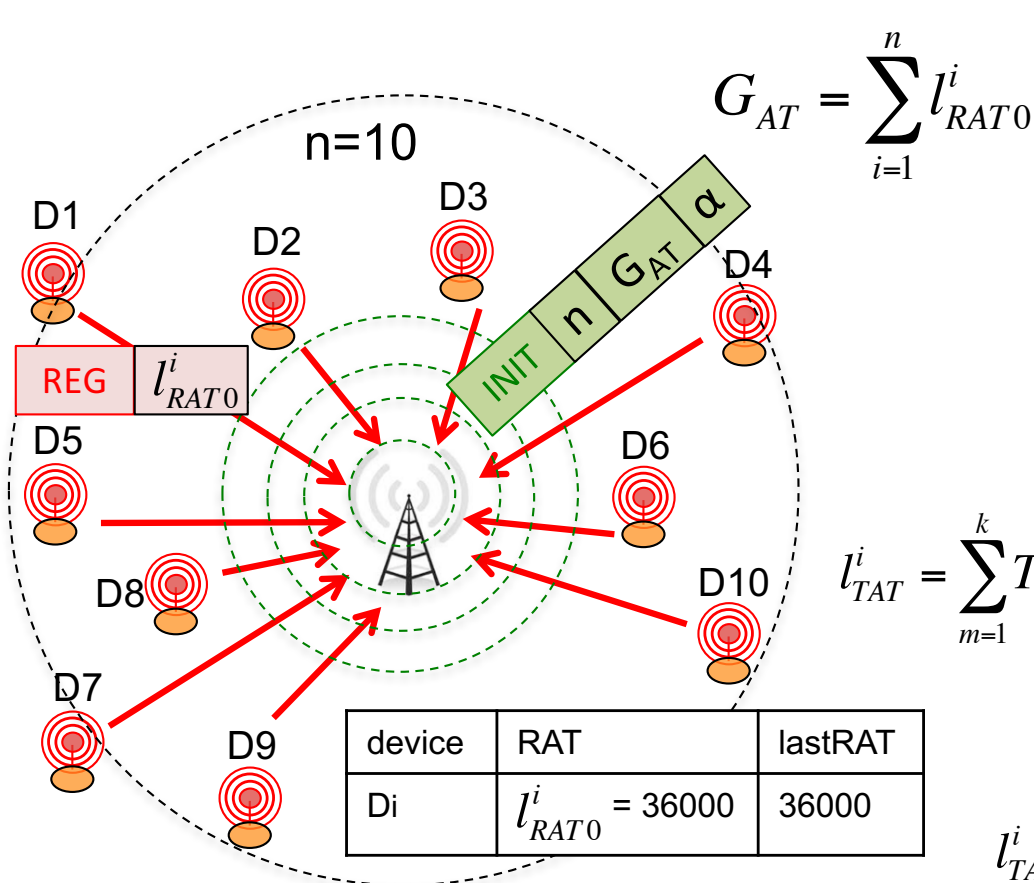

$$l^i_{TAT} = \sum_{m=1}^k ToA(S_m^i)$$

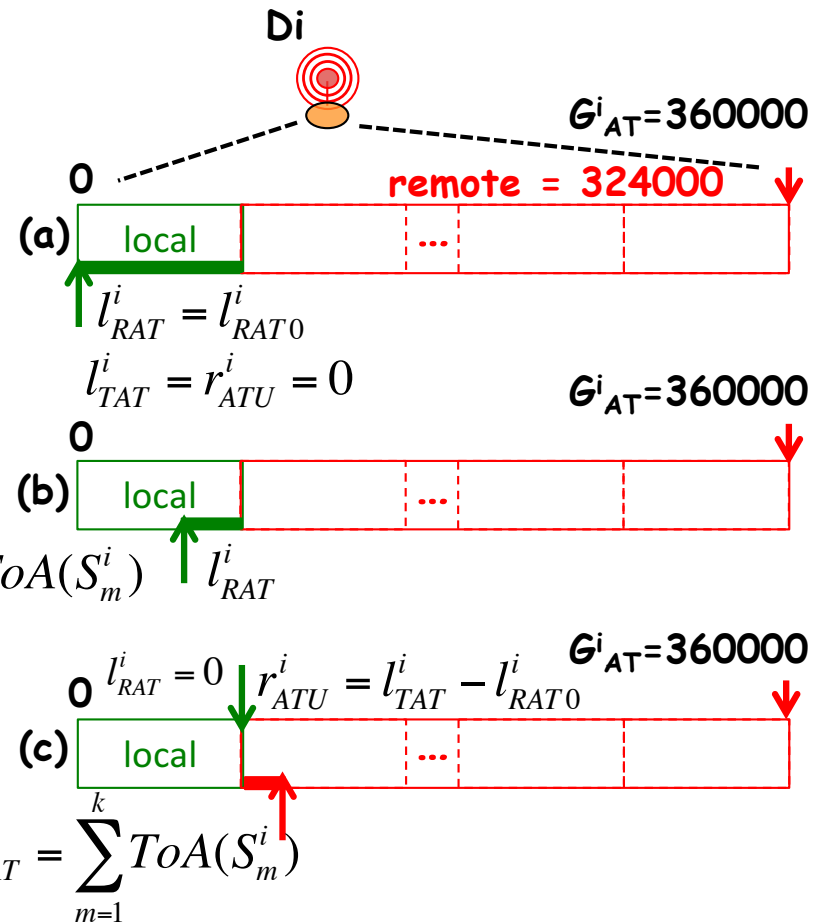

A device can transmit more if needed, provided that other devices will decrease their radio activity time accordingly.



# DISTRIBUTING REMOTE ACTIVITY TIME USAGE

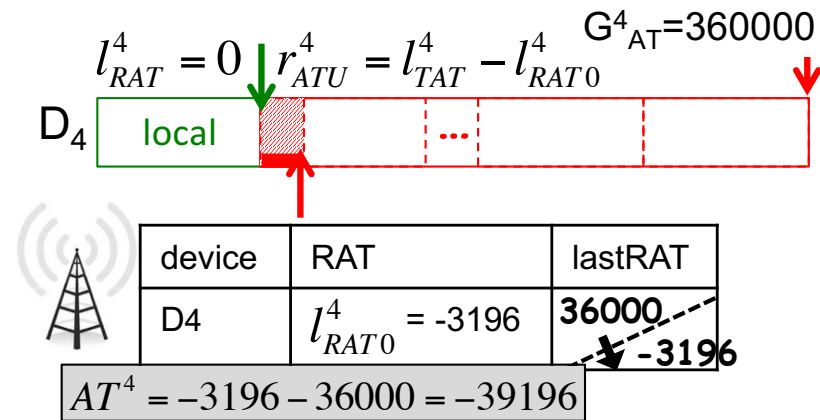
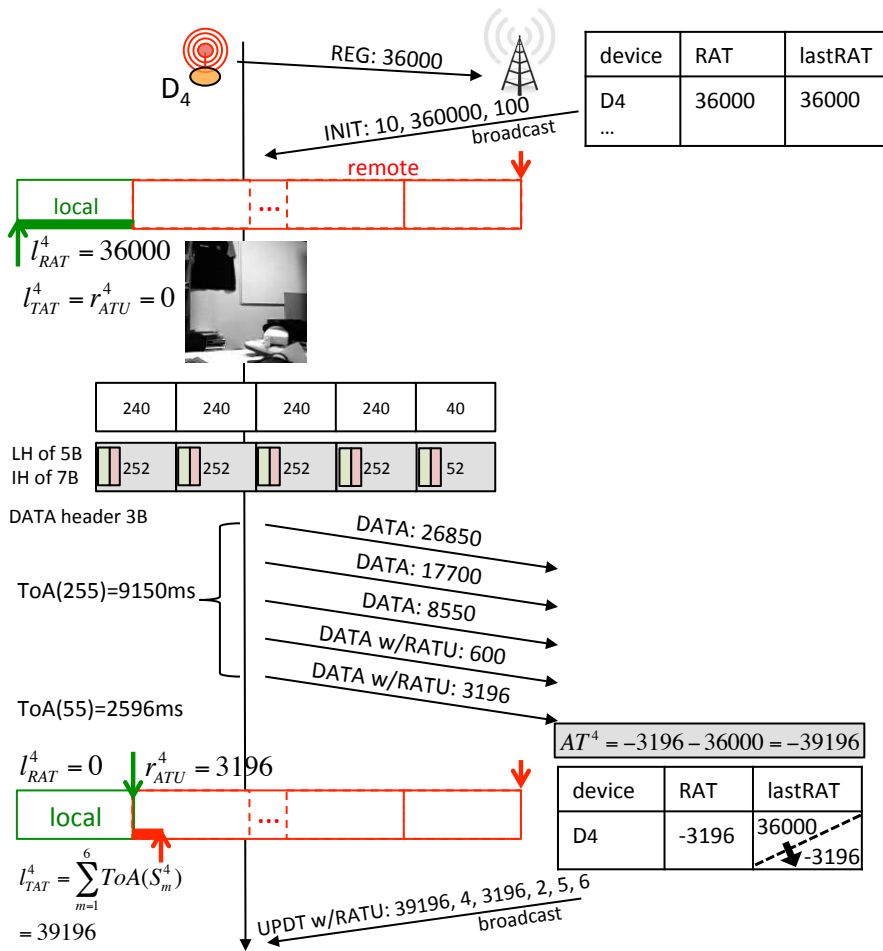

UPDT w/RATU	39196	4	$n_d=2$	3196	5	6
-------------	-------	---	---------	------	---	---

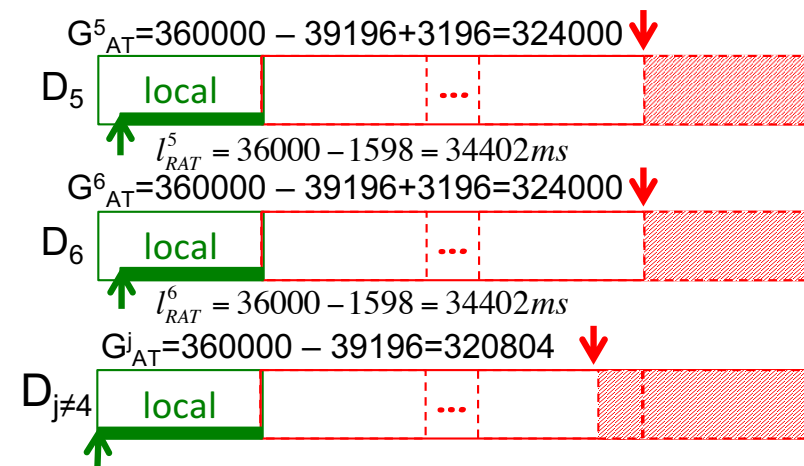



# TUTORIALS/RESOURCES



<https://github.com/CongducPham/tutorials>

**WAZIUP**  
 101 822020 grant agreement number 887167

**Low-cost LoRa IoT devices and gateway FAQ**

1) **What is Internet-of-Thing (IoT)?**  
 From IERC (European Research Cluster on the Internet of Things)  
 The IERC definition states that IoT is "a dynamic global network infrastructure with self-configuring capabilities based on standard and interoperable communication protocols where physical and virtual "things" have identities, physical attributes, and virtual personalities and use intelligent interfaces, and are seamlessly integrated into the information network."  
 From <http://www.gartner.com/it-glossary/internet-of-things/>  
 "The Internet of Things (IoT) is the network of physical objects that contain embedded technology to communicate and sense or interact with their internal states or the external environment."  
 From <http://internetofthingsagenda.techtarget.com/definition/Internet-of-Things-IoT>  
 "The Internet of Things (IoT) is a system of interrelated computing devices, mechanical and digital machines, objects, animals or people that are provided with unique identifiers and the ability to transfer data over a network without requiring human-to-human or human-to-computer interaction."

2) **What is WAZIUP?**  
 The EU H2020 WAZIUP project, namely the Open Innovation Platform for IoT-Big Data in Sub-Saharan Africa is a collaborative research project using cutting edge technology applying IoT and Big Data to improve the working conditions in the rural ecosystem of Sub-Saharan Africa. First, WAZIUP operates by involving farmers and breeders in order to define the platform specifications in focused validation cases. Second, while tackling challenges which are specific to the rural ecosystem, it also engages the flourishing ICT ecosystem in those countries by fostering new tools and good practices, entrepreneurship and start-ups. Aimed at boosting the ICT sector, WAZIUP proposes solutions aiming at long term sustainability.  
 WAZIUP will deliver a communication and big data application platform and generate locally the know-how by training by use case and examples. The use of standards will help to create an interoperable platform, fully open source, oriented to radically new paradigms for innovative applications/services delivery. WAZIUP is driven by the following visions:  
 1. Empower the African rural empower the African role of rapid urbanization and support the necessary and breeding on a new scale

Author : Congduc Pham, University of Pau  
 Last update : 07.09.2016

**TUTORIAL ON HARDWARE & SOFTWARE FOR LOW-COST LONG-RANGE IOT**

**WAZIUP**

LIUPPA T21 team

PROF. CONGDUC PHAM  
[HTTP://WWW.UNIV-PAU.FR/~CPHAM](http://www.univ-pau.fr/~cpham)  
 UNIVERSITE DE PAU, FRANCE

UNIVERSITE DE PAU ET DES PAYS DE L'ADOUR

**LOW-COST LORA IOT DEVICE: A STEP-BY-STEP TUTORIAL**

**WAZIUP**

LIUPPA T21 team

PROF. CONGDUC PHAM  
[HTTP://WWW.UNIV-PAU.FR/~CPHAM](http://www.univ-pau.fr/~cpham)  
 UNIVERSITE DE PAU, FRANCE

UNIVERSITE DE PAU ET DES PAYS DE L'ADOUR

**BUILDING AN IOT DEVICE FOR OUTDOOR USAGE: A STEP-BY-STEP TUTORIAL**

**WAZIUP**

LIUPPA T21 team

PROF. CONGDUC PHAM  
[HTTP://WWW.UNIV-PAU.FR/~CPHAM](http://www.univ-pau.fr/~cpham)  
 UNIVERSITE DE PAU, FRANCE

UNIVERSITE DE PAU ET DES PAYS DE L'ADOUR

**LOW-COST LORA IOT DEVICE: SUPPORTED PHYSICAL SENSORS**

**WAZIUP**

LIUPPA T21 team

PROF. CONGDUC PHAM  
[HTTP://WWW.UNIV-PAU.FR/~CPHAM](http://www.univ-pau.fr/~cpham)  
 UNIVERSITE DE PAU, FRANCE

UNIVERSITE DE PAU ET DES PAYS DE L'ADOUR

**LOW-COST LORA GATEWAY: A STEP-BY-STEP TUTORIAL**

**WAZIUP**

LIUPPA T21 team

PROF. CONGDUC PHAM  
[HTTP://WWW.UNIV-PAU.FR/~CPHAM](http://www.univ-pau.fr/~cpham)  
 UNIVERSITE DE PAU, FRANCE

UNIVERSITE DE PAU ET DES PAYS DE L'ADOUR

**LOW-COST LORA IOT: USING THE WAZIUP DEMO KIT**

**WAZIUP**

LIUPPA T21 team

PROF. CONGDUC PHAM  
[HTTP://WWW.UNIV-PAU.FR/~CPHAM](http://www.univ-pau.fr/~cpham)  
 UNIVERSITE DE PAU, FRANCE

UNIVERSITE DE PAU ET DES PAYS DE L'ADOUR

**Low-cost IoT device**

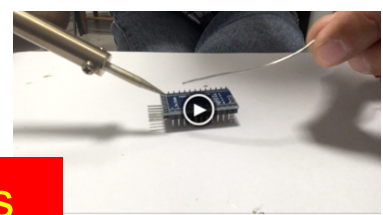

**+43000 views**

[https://www.youtube.com/watch?v=YsKbJeeav\\_M](https://www.youtube.com/watch?v=YsKbJeeav_M)

**Low-cost IoT gateway**



<https://www.youtube.com/watch?v=mj8ltKA14PY>