

MAKING IOT HAPPENING: THE LOW-COST APPROACH BY WAZIUP FOR RURAL APPLICATIONS

SWINBURNE UNIVERSITY OF TECHNOLOGY SARAWAK
CENTRE FOR DIGITAL FUTURE
FEBRUARY 6TH, 2018



DISRUPTIVE
INTERNET
OF THINGS
APPLICATIONS
IN AFRICA

I.O.T
ONLINE
COMMUNITY
BIG DATA
INNOVATIONS
MAIL
CHAT
WIFI
IDEA
web
CHAT
MAIL
COMMUNITY
I.O.T
ONLINE

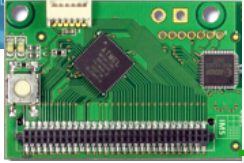
WAZIUP

Logos at the bottom: European Union, CTIC, Farmerline, iSpace, INNOVATION, INNOVATION, coders africa, INNOTECH, CREATE-NET, and others.



PROF. CONGDUC PHAM
[HTTP://WWW.UNIV-PAU.FR/~CPHAM](http://www.univ-pau.fr/~cpham)
UNIVERSITÉ DE PAU, FRANCE

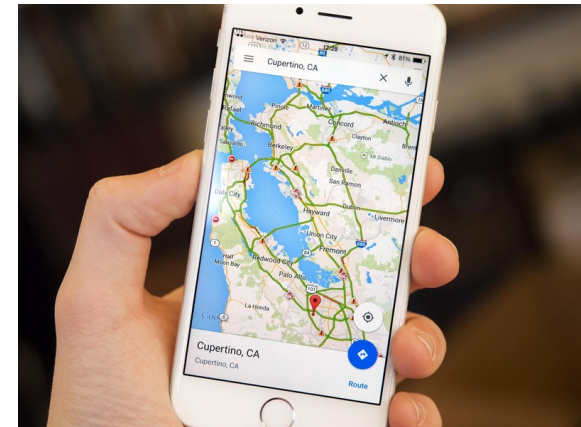
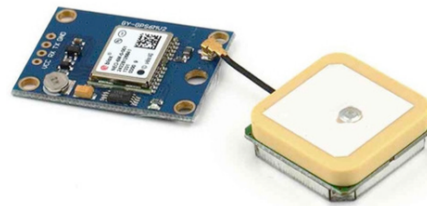


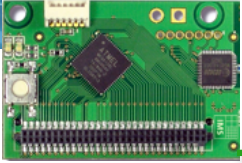


IoT & PHYSICAL WORLD

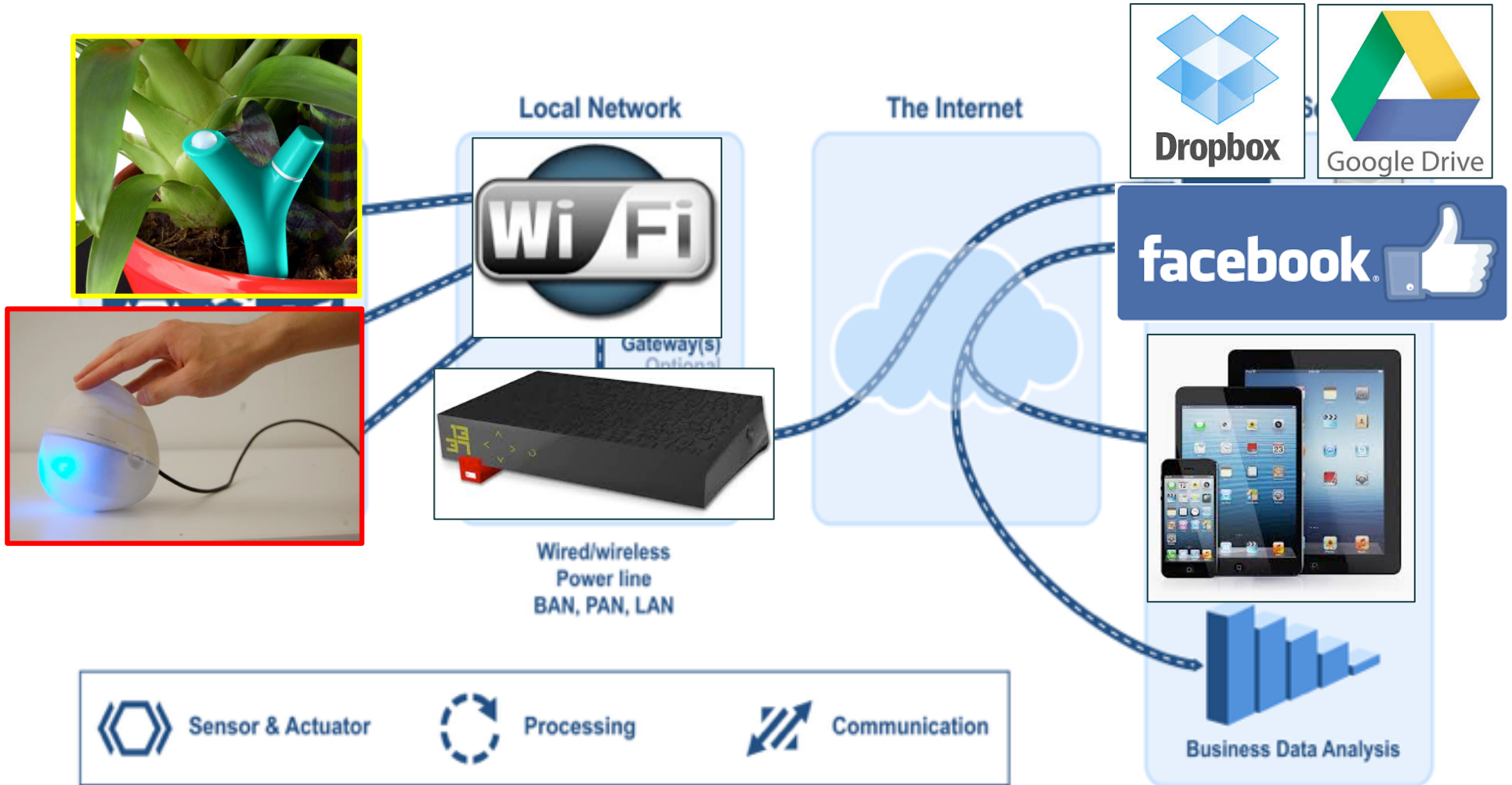


Waste Container connected sensor

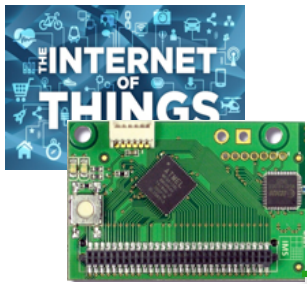




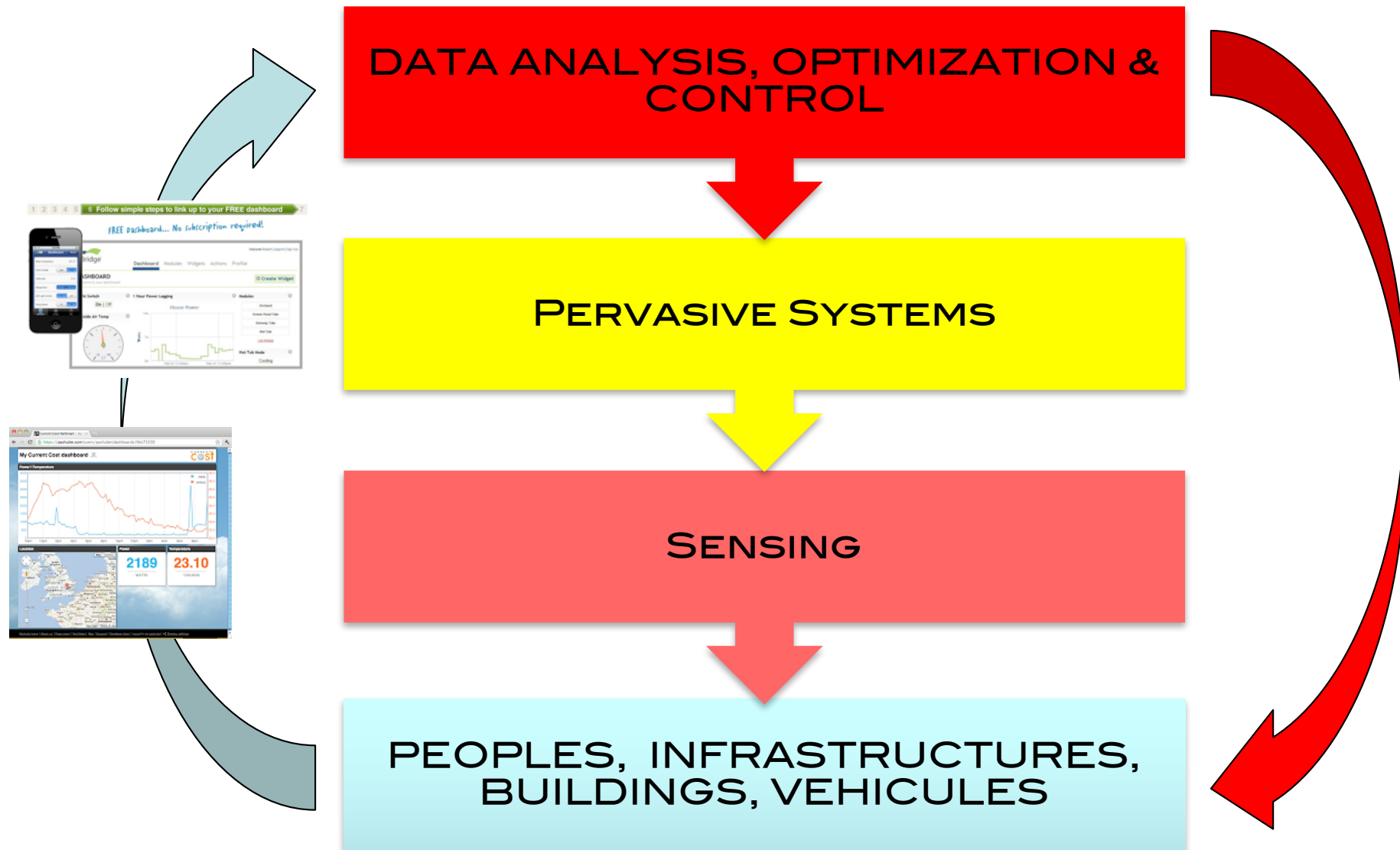
"IOT" FOR THE MASSES

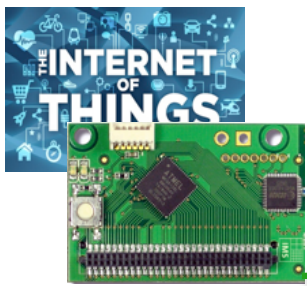


Pictures from ArchitectCorner



CONTROL, OPTIMIZE & INSTRUMENT !





IOT=DEVELOPMENT OPPORTUNITIES



Irrigation



Livestock farming



Fish farming & aquaculture



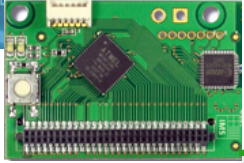
Storage & logistic



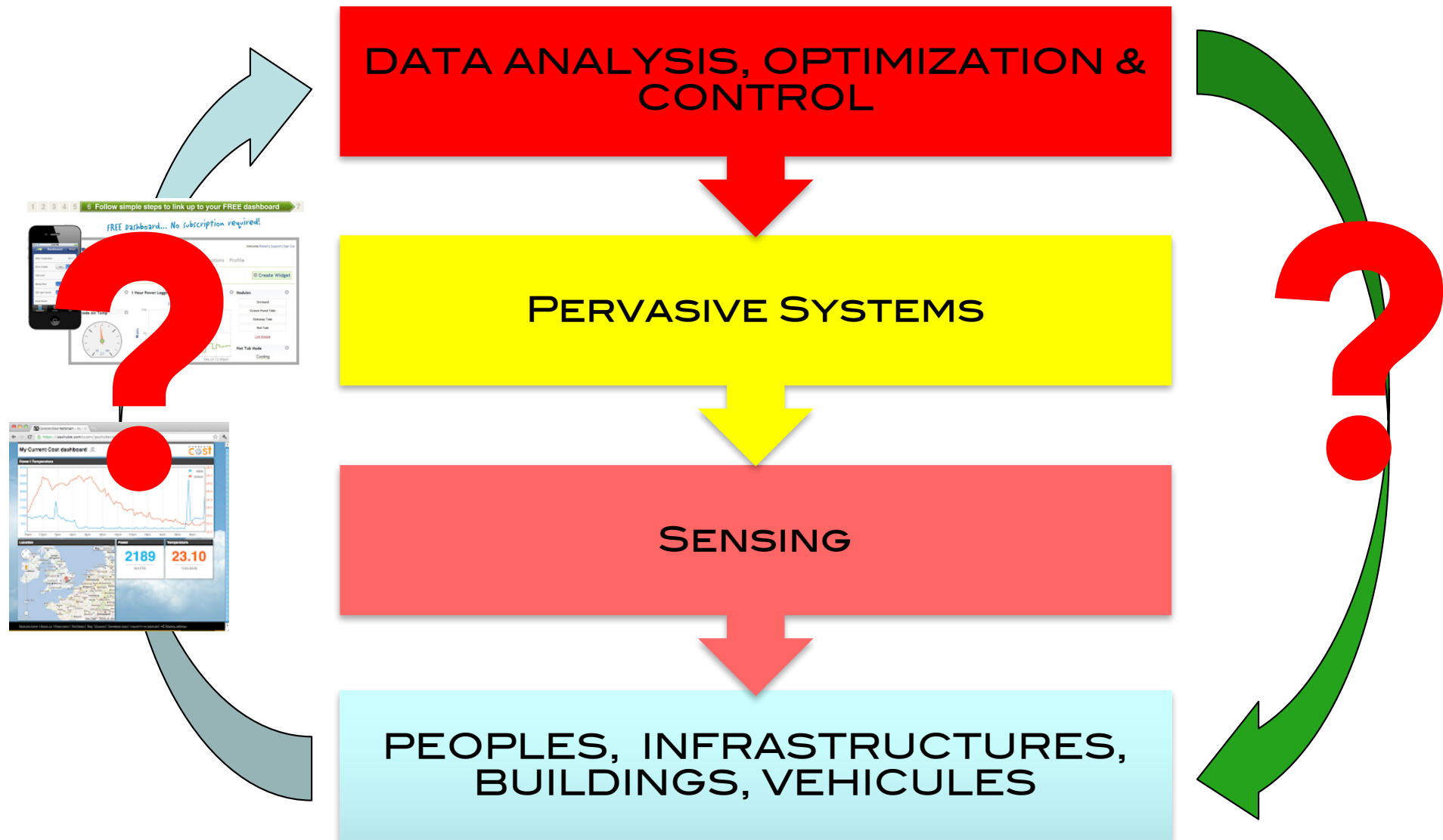
Agriculture

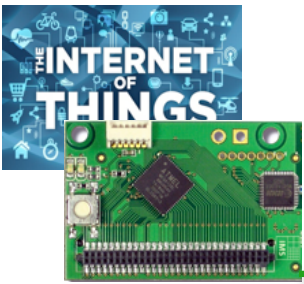


Fresh water



COLLECT DATA?

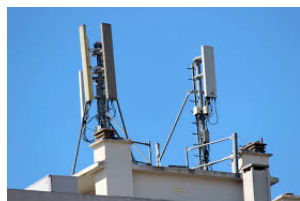
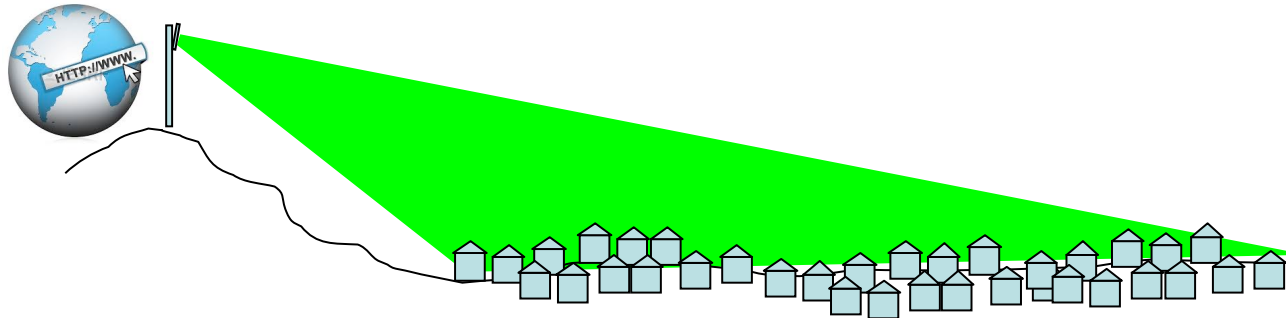




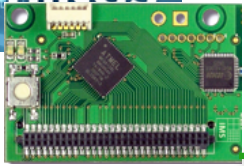
TELEMETRY AND TRANSMISSION COST



Moisture/
Temperature of
storage areas

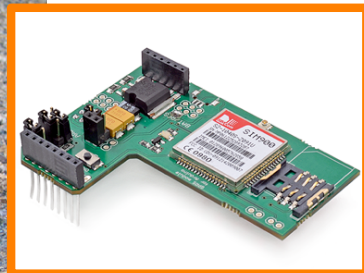
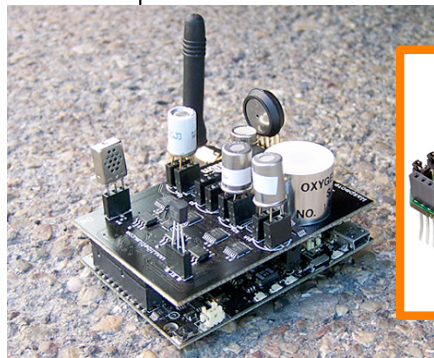
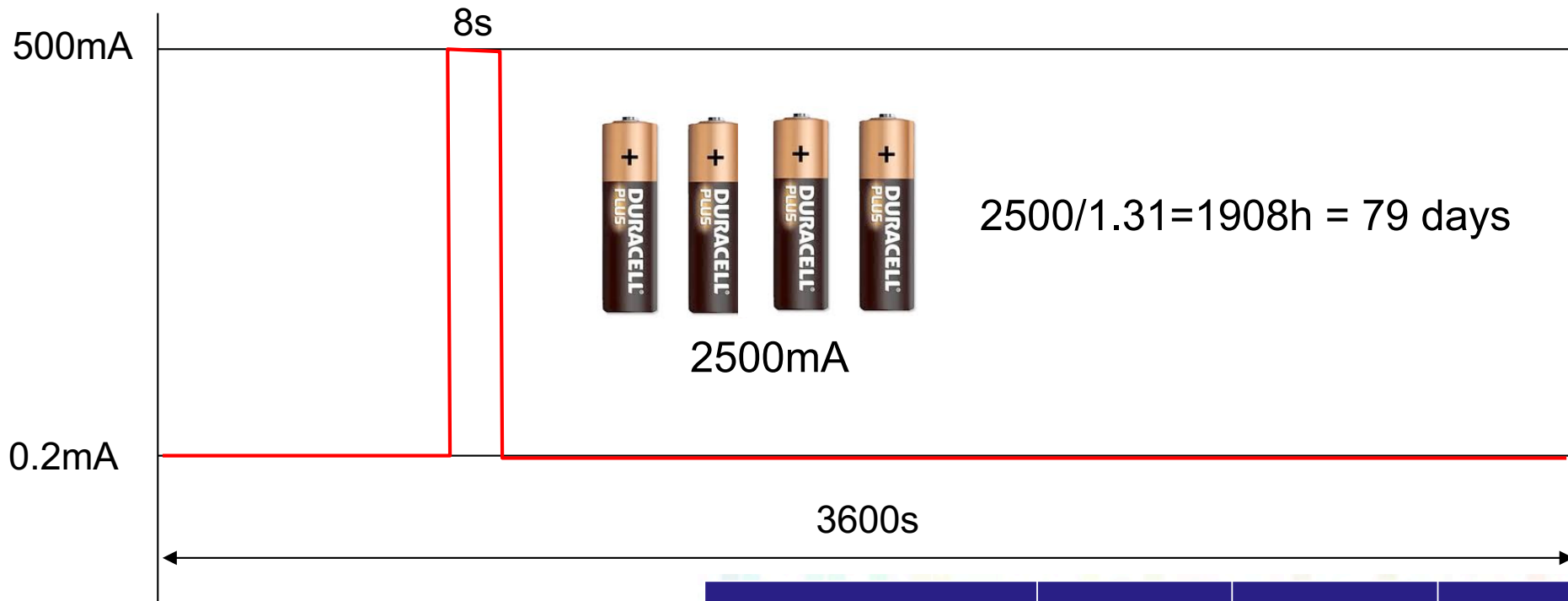


Technology	2G	3G	LAN
Range (I=Indoor, O=Outdoor)	N/A	N/A	O: 300m I: 30m
Tx current consumption	200-500mA	500-1000mA	100-300mA
Standby current	2.3mA	3.5mA	NC



ENERGY CONSIDERATION

TX power: 500mA. Mean consumption: $(8 \times 500 + 3592 \times 0.2) / 3600 = 1.31 \text{mA}$

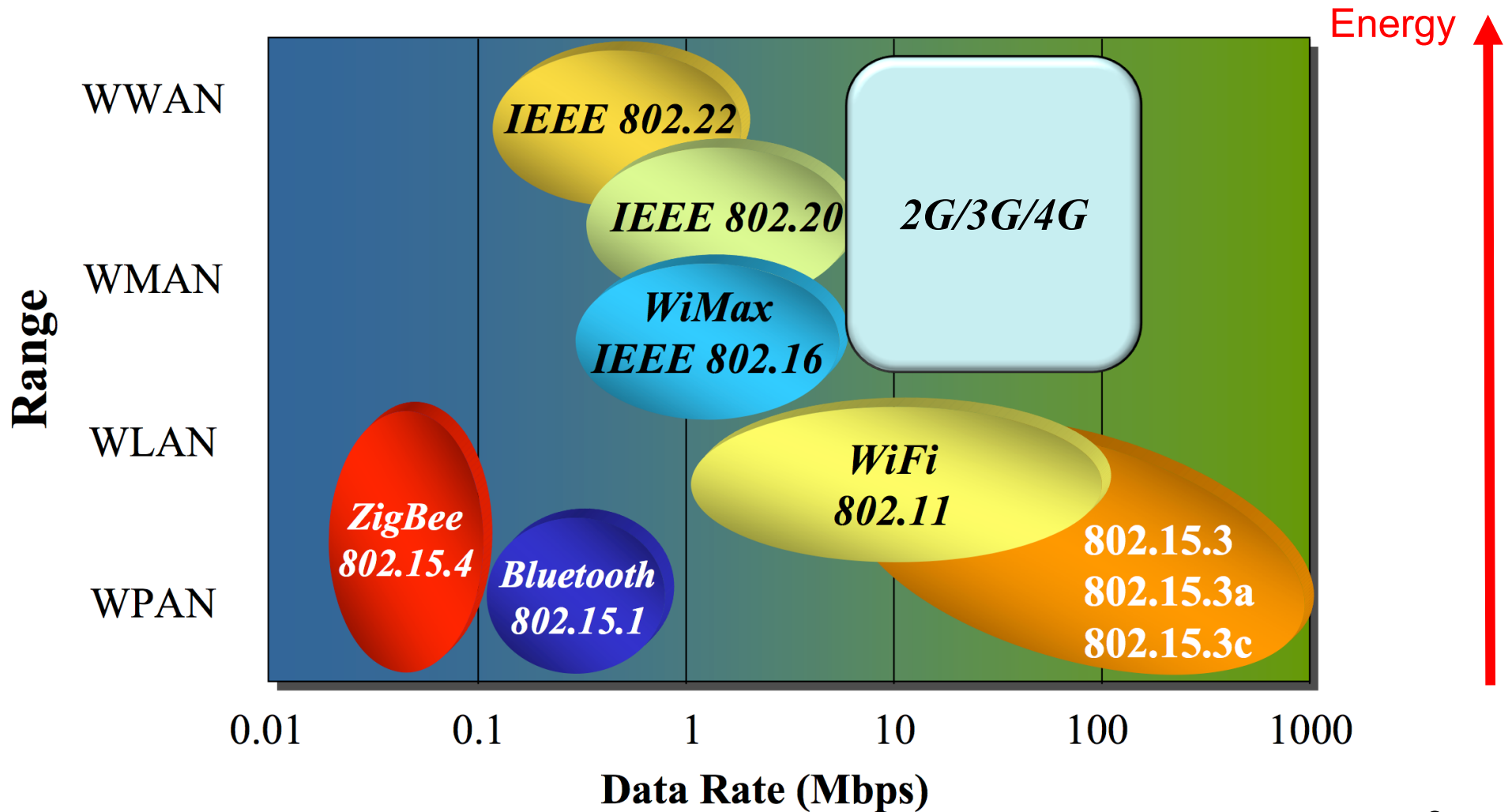


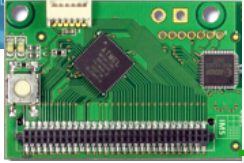
Technology	2G	3G	LAN
Range (I=Indoor, O=Outdoor)	N/A	N/A	O: 300m I: 30m
Tx current consumption	200-500mA	500-1000mA	100-300mA
Standby current	2.3mA	3.5mA	NC



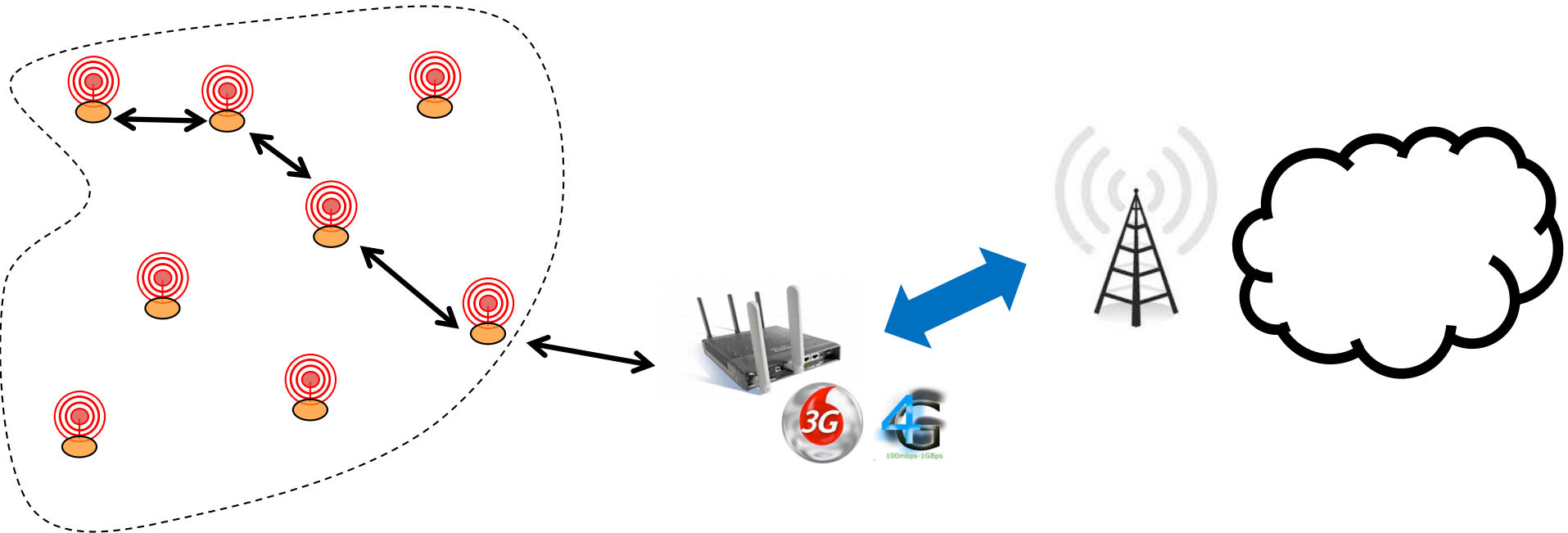
THE WIRELESS SPACE

Energy-Range dilemma



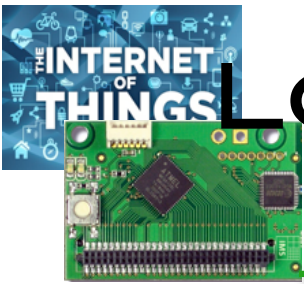


LOWER ENERGY MEANS SHORTER RANGE!



How bad is multi-hop routing?

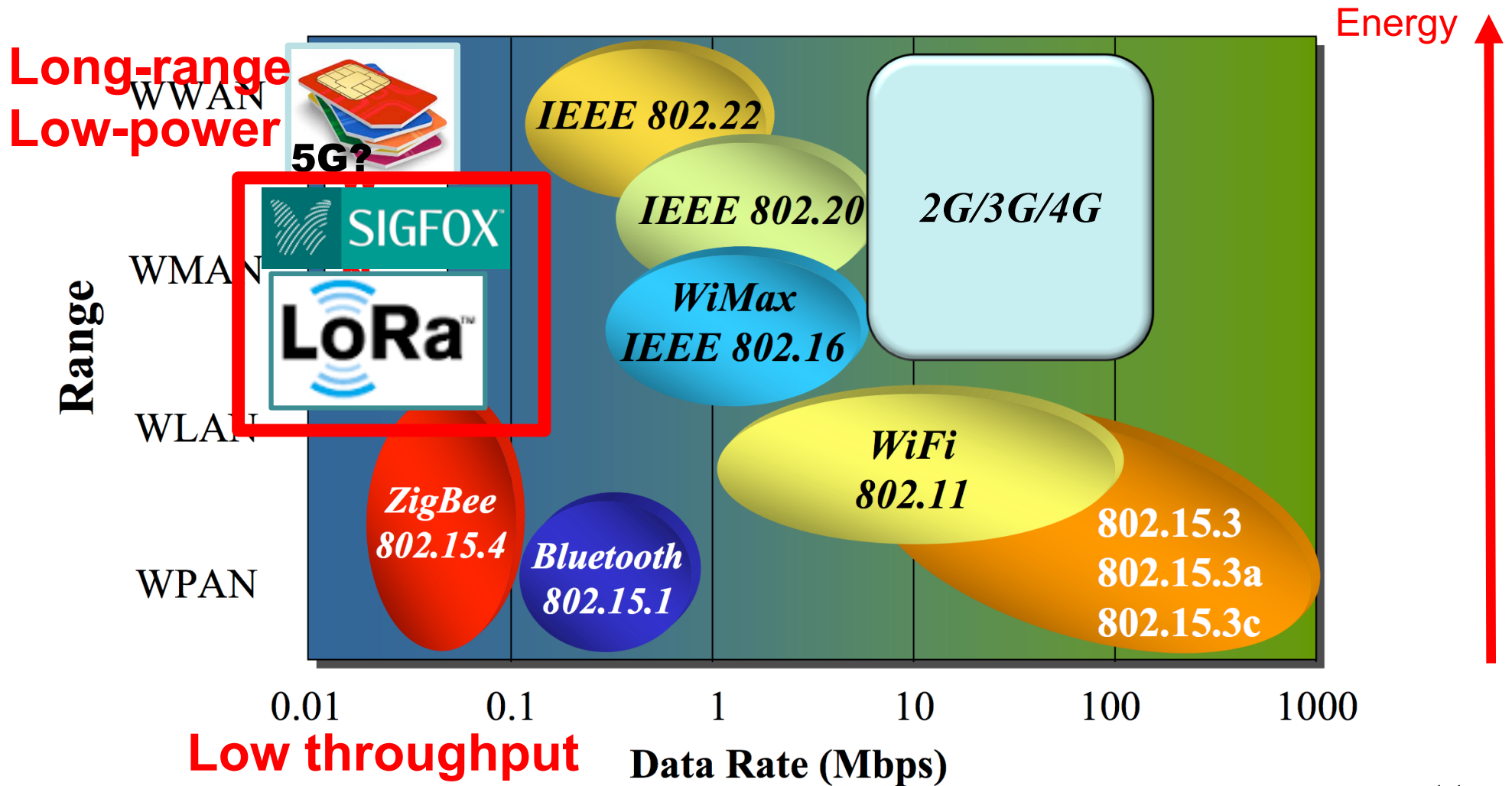
- Increases packet loss rate
- Increases end-to-end delivery time
- Consumes more energy as intermediate nodes must relay packets
- Limits energy saving mechanism benefits as both sender and intermediate node must be somehow synchronized
- Is impacted by intermediate node failure

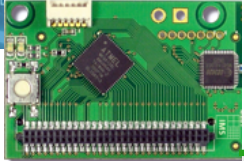


LOW-POWER & LONG-RANGE RADIO TECHNOLOGIES



Energy-Range dilemma



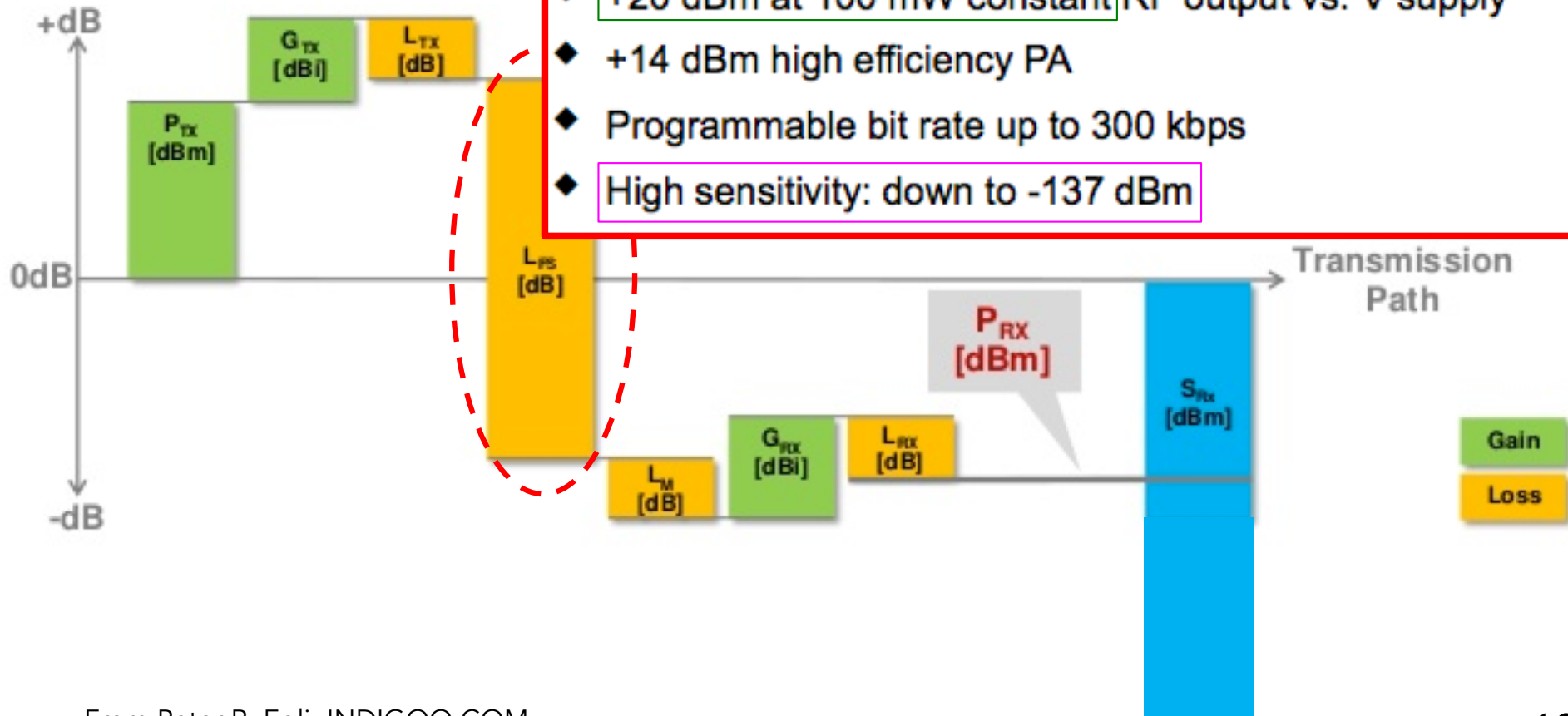


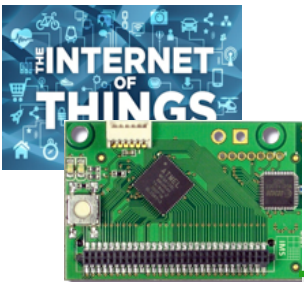
LINK BUDGET OF LPWAN

$$P_{RX} = P_{TX} + G_{TX} - L_{TX} - L_{FP} - L_M + G_{RX} - L_{RX} + S_{RX}$$

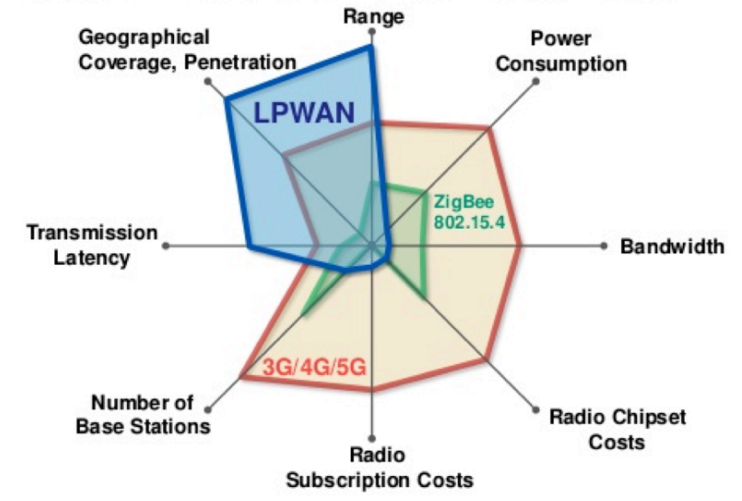
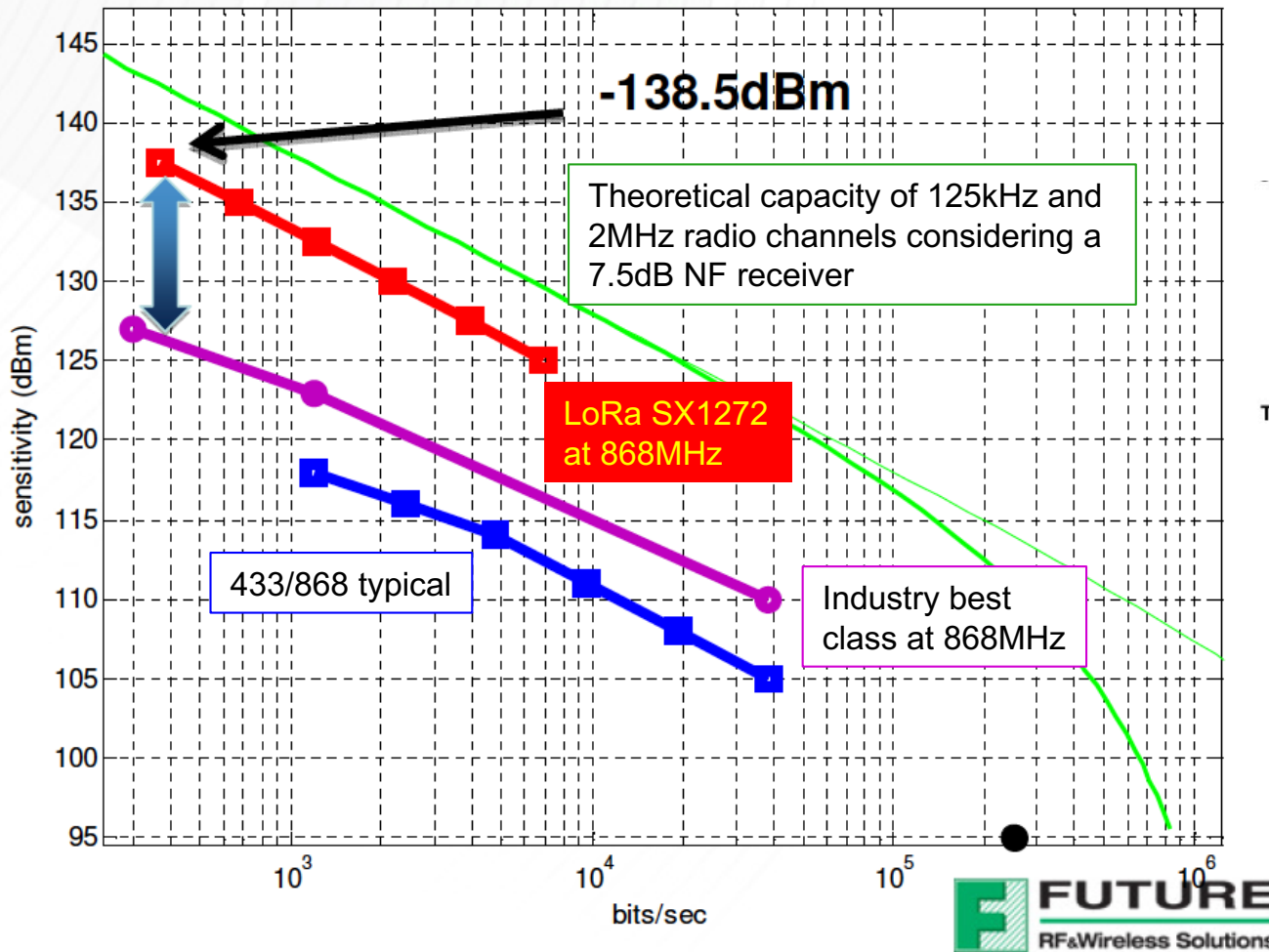
KEY PRODUCT FEATURES

- ◆ LoRa™ Modem
- ◆ 157 dB maximum link budget
- ◆ +20 dBm at 100 mW constant RF output vs. V supply
- ◆ +14 dBm high efficiency PA
- ◆ Programmable bit rate up to 300 kbps
- ◆ High sensitivity: down to -137 dBm





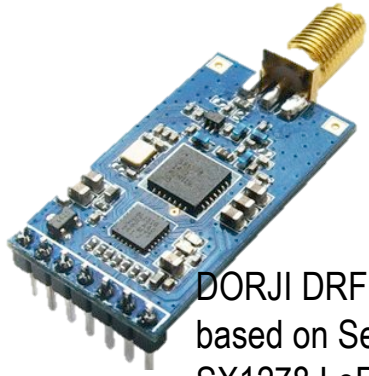
THE LOW POWER WAN (LPWAN) REVOLUTION



From Peter R. Egli, INDIGOO.COM

The lower the receiver sensitivity, the longer is the range!

LORA MODULES FROM SEMTECH'S SX127X CHIPS



DORJI DRF1278DM is based on Semtech SX1278 LoRa 433MHz



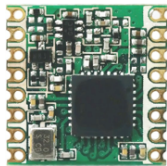
Libelium LoRa is based on Semtech SX1272 LoRa 863-870 MHz for Europe



inAir9 based on SX1276



Froggy Factory LoRa module (Arduino)



HopeRF RFM series



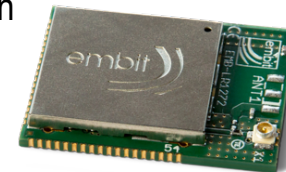
HopeRF HM-TRLR-D



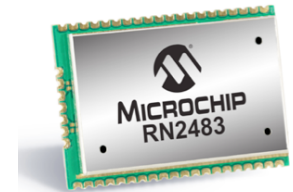
LinkLabs Symphony module



IMST IM880A-L is based on Semtech SX1272 LoRa 863-870 MHz for Europe



Embit LoRa



LoRa™ Long-Range Sub-GHz Module (Part # RN2483)

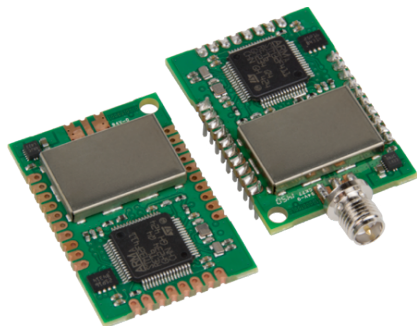
Microship RN2483



Adeunis ARF8030AA- Lo868



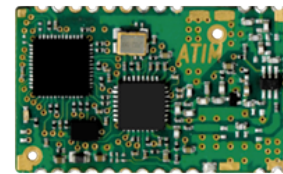
habSupplies



Multi-Tech MultiConnect mDot



AMIHO AM093



ARM-Nano N8 LoRa module from ATIM

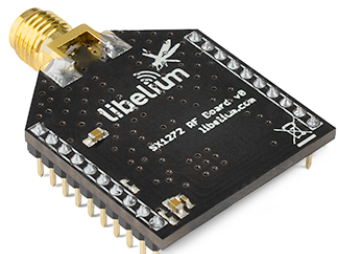


SODAQ LoRaBee Embit

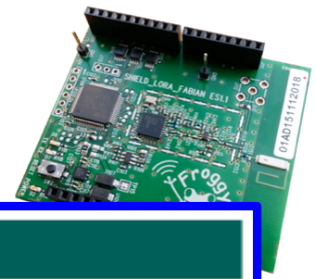


SODAQ LoRaBee RN2483

LoRa MODULES FROM SEMTECH'S SX127X CHIPS



Libelium LoRa is based on Semtech SX1272 LoRa 863-870 MHz for Europe

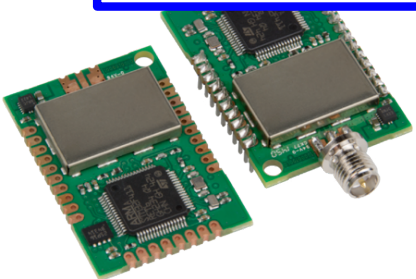


LoRa® Transceivers							
Part Number	Frequency Range (MHz)	Link Budget (dB)	Rx Current (mA)	FSK max DR (kbps)	LoRa DR (kbps)	Max Sensitivity (dBm)	Tx Power (dBm)
SX1272	860 – 1020	158	10	300	0.3 – 37.5	-137	+ 20
SX1273	860 – 1020	150	10	300	1.7 – 37.5	-130	+ 20
SX1276	137 – 1020	168	9.9	300	0.018 – 37.5	-148	+ 20
SX1277	137 – 1020	158	9.9	300	1.7 – 37.5	-139	+ 20
SX1278	137 – 525	168	9.9	300	0.018 – 37.5	-148	+ 20

Ho
RF
se

a

Module

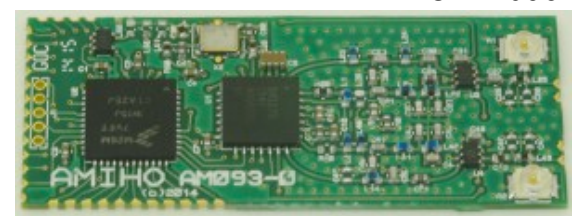


Multi-Tech MultiConnect mDot

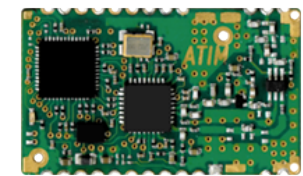


Adeunis ARF8030AA- Lo868

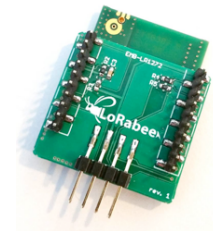
habSupplies



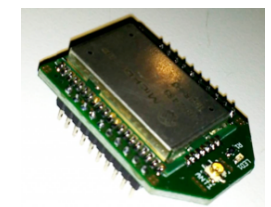
AMIHO AM093



ARM-Nano N8 LoRa module from ATIM

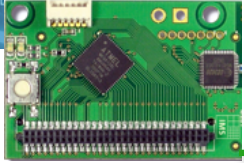


SODAQ LoRaBee Embit



SODAQ LoRaBee RN2483

Microship RN2483



ENERGY CONSUMPTION COMPARAISON



Tables from Semtech

Technology	2G	3G	LAN	ZigBee	Lo Power WAN
Range (I=Indoor, O=Outdoor)	N/A	N/A	O: 300m I: 30m	O: 90m I: 30m	Same as 2G/3G
Tx current consumption	200-500mA	500-1000mA	100-300mA	18mA	18mA-40mA
Standby current	2.3mA	3.5mA	NC	0.003mA	0.001mA
Energy harvesting (solar, other)	No	No	No	Possible	Possible
Battery 2000mAh (LR6 battery)	4-8 hours(com) 36 days(idle)	2-4 hours(com) X hours(idle)	50 hours(com) X hours(idle)	60hours (com)	120 hours(com) 10 year(idle)

TX power: 30mA. Mean consumption: $(8 \times 30 + 3592 \times 0.2) / 3600 = 0.266 \text{mA}$

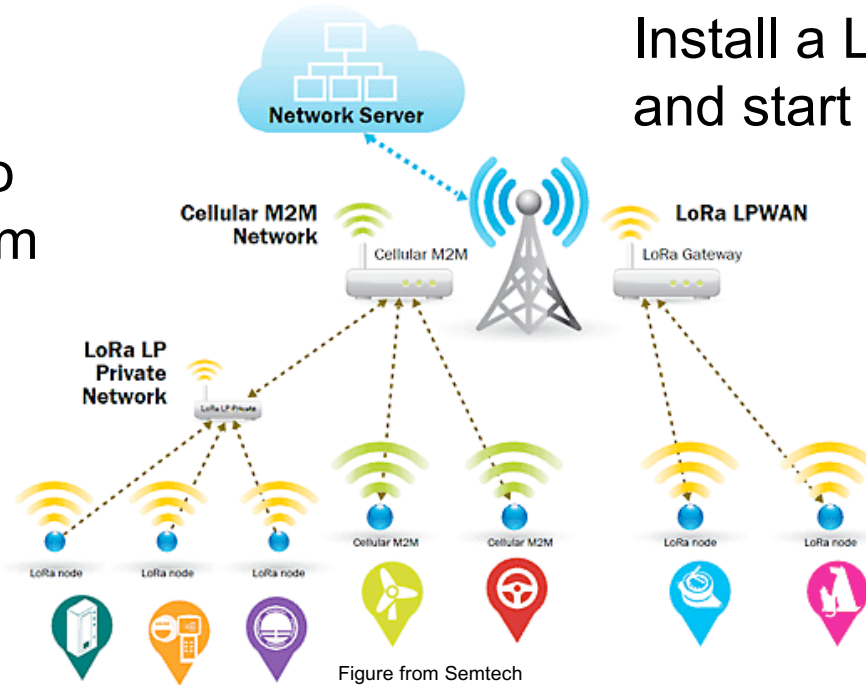
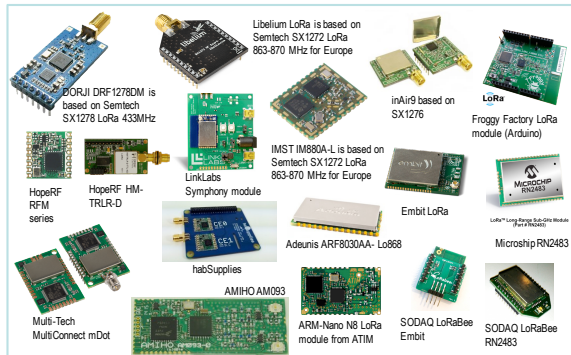
$2500 / 0.266 = 9398 \text{h} = 391 \text{ days} = 13 \text{ months}$



BUILDING PRIVATE LONG-RANGE NETWORKS



Add LoRa radio module to your preferred dev platform



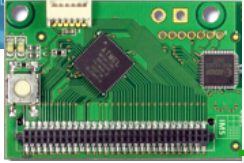
Install a LoRa gateway and start collecting data

Figure from Semtech

10-15kms

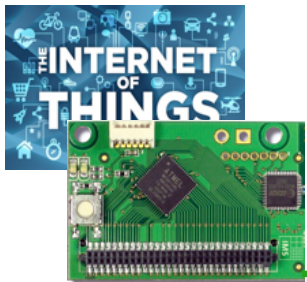
LoRa™

- No subscription
- Deploy own network
- Low energy consumption



DEDICATED IOT CLOUD





USING ThingSpeak



ThingSpeak Channels Apps Blog Support

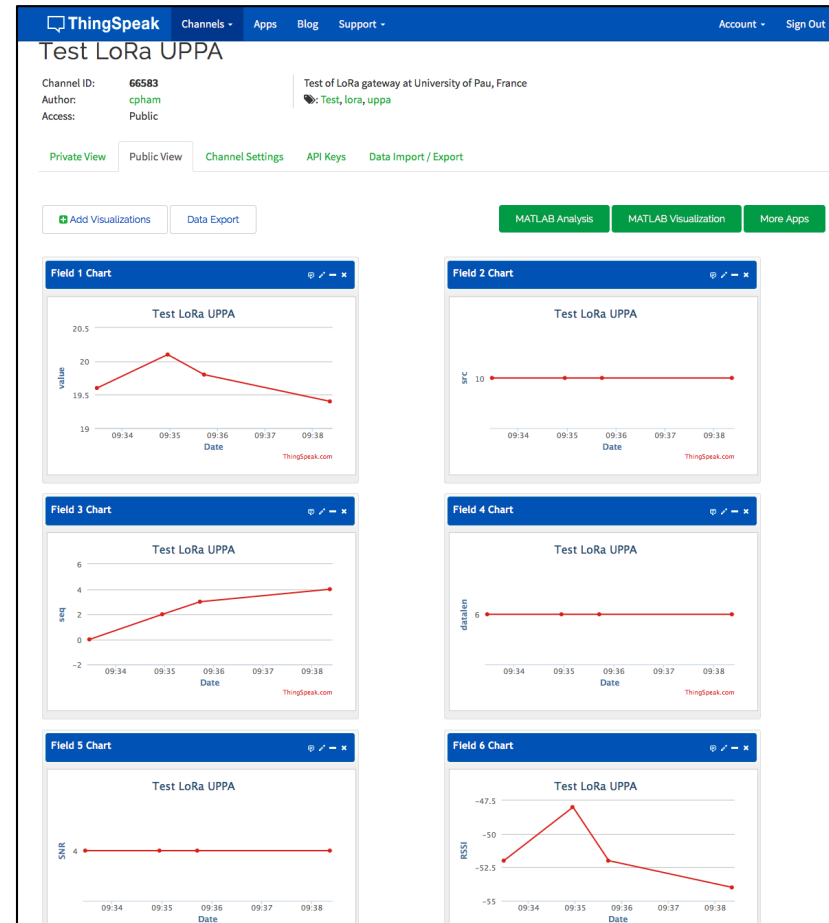
User: cpham

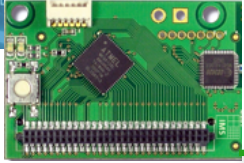
Test LoRa UPPA

Channel ID: **66583**
 Author: **cpham**
 Test of LoRa gateway at University of Pau, France

Test, lora, uppa

19.6





USING



GroveStreams



Browser address bar: <https://www.grovestreams.com/observationStudio.html?org=7a5de802-5d71-319>

Page Title: University of Pau

Component Studio | Admin | (0,6,0)

Observation Studio

Components: sensor3, temp, sensor6

temp

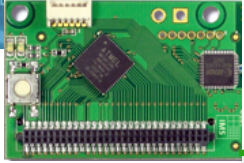
Row	Time	Value
1	22:26:03.633	25.87
2	22:23:40.604	25.87
3	22:21:35.489	25.87
4	22:17:32.907	25.87
5	22:15:41.998	25.87
6	22:11:40.452	23.43
7	22:07:36.184	23.43
8	22:03:33.273	22.94
9	21:59:33.532	23.43
10	21:55:28.121	23.92
11	21:51:22.015	22.94
12	21:47:22.836	23.92
13	21:45:17.126	23.92
14	21:41:13.750	22.94

Chart Type

Quick View

temp **25.87**
Last updated 22:27:57 (3m 59s ago) 22:27:57

Refresh

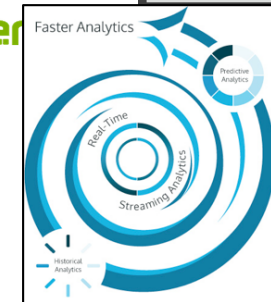
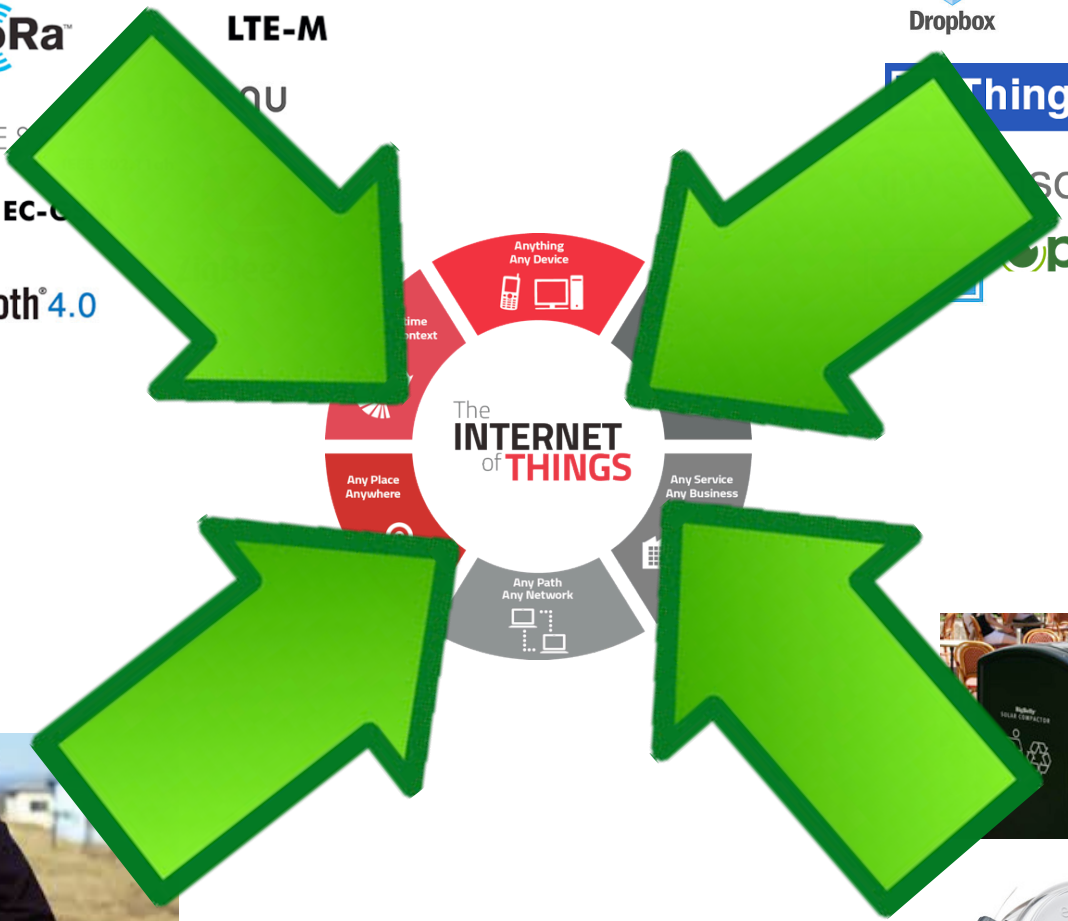


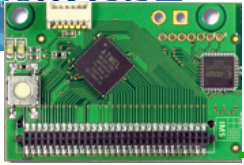
IOT BECOMES REALITY!



Logos of various IoT-related companies and technologies:

- SIGFOX: One network A billion dreams
- nwave
- LoRa™
- LTE-M
- NB-LTE
- WEIGHTLESS
- DASH7 ALLIANCE
- Bluetooth® 4.0
- Dropbox
- Firestore
- FIWARE
- Axeda®
- ioBridge® Connect things.
- ThingSpeak
- GroveStreams
- SensorCloud™
- OpenReel
- freeboard





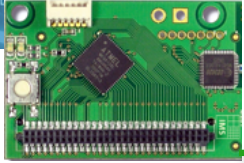
WAZIUP: LOW-COST IOT



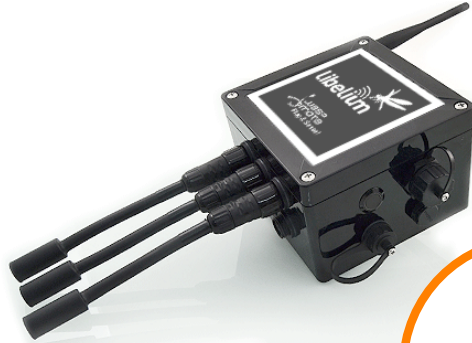
[ABOUT »](#) [TECHNOLOGIES »](#) [COMMUNITY](#) [NEWS & EVENT »](#) [DOWNLOADS](#) [DEV KIT](#) [FAQ](#) [CONTACT](#)


HORIZON 2020

AFFORDABLE
TECHNOLOGIES
TO
EMPOWER
RURAL ECONOMIES



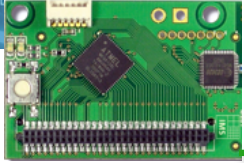
MATURATION OF THE IOT MARKET...



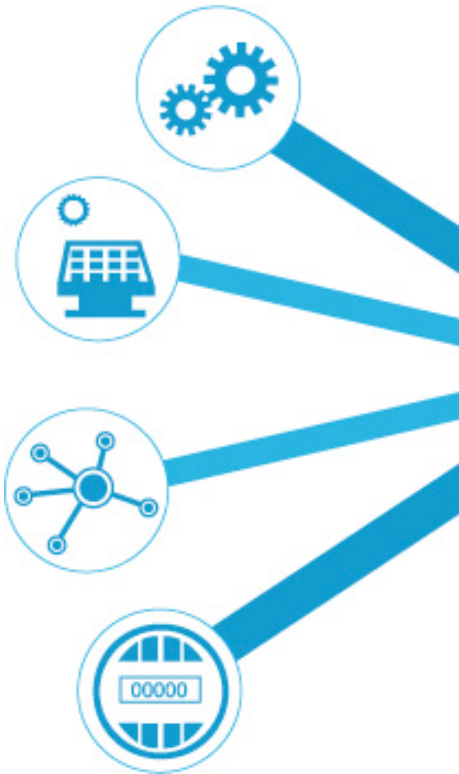
... but not adapted for rural developing countries context & environment

- Too expensive
- Too integrated
- Highly specialized
- Difficult to customize
- Difficult to upgrade





INTERNET, CLOUD & BIG DATA ANALYTICS



Internet connectivity is weak and expensive!

Nearly impossible in remote/rural areas



Predictive Maintenance



Outage Management



Fraud Detection

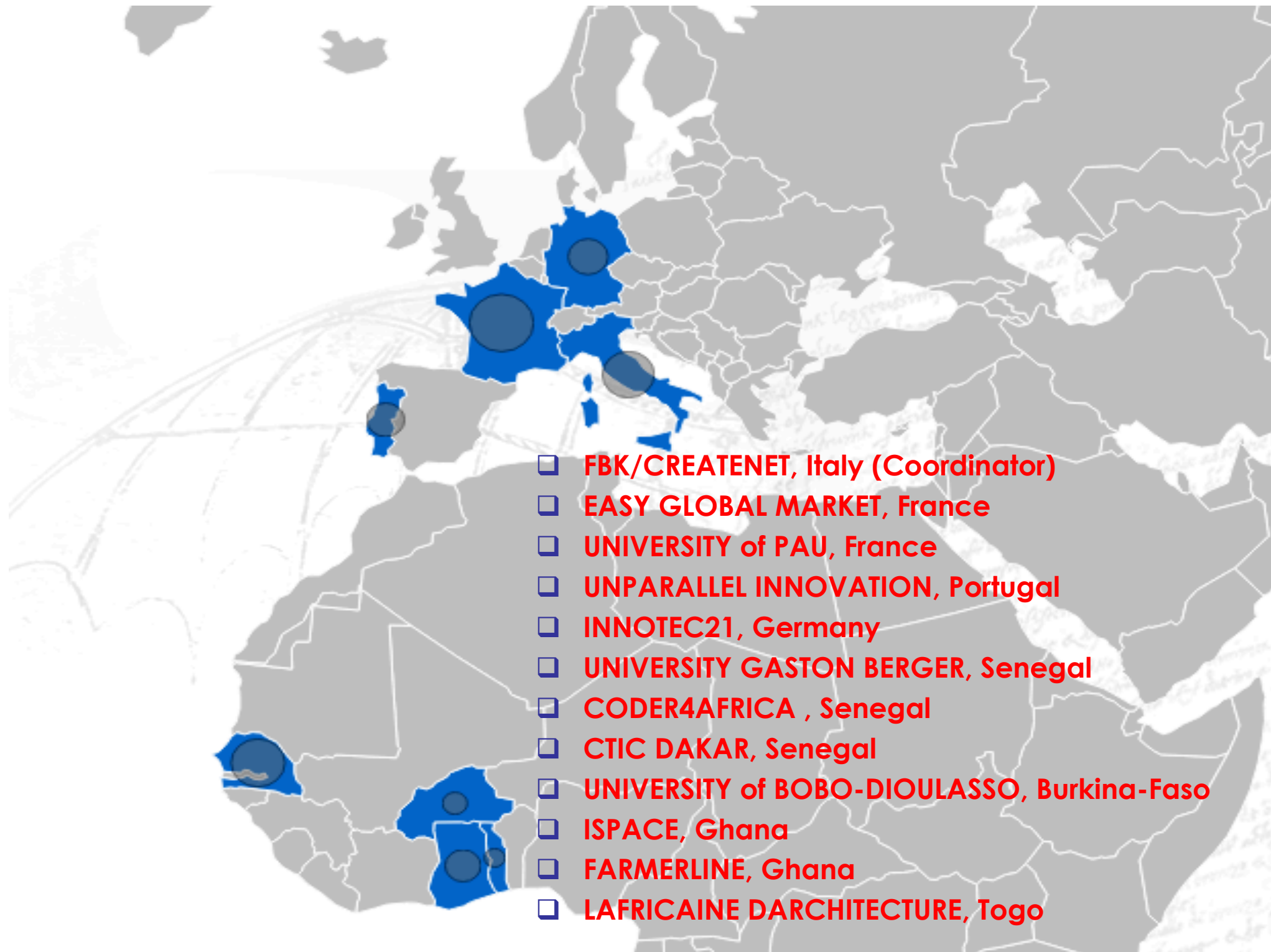


Demand/Supply Optimization

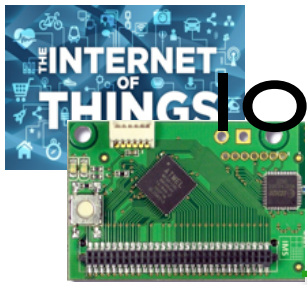


Customer Engagement

Graphics from <http://www.vitria.com/iot-analytics/>



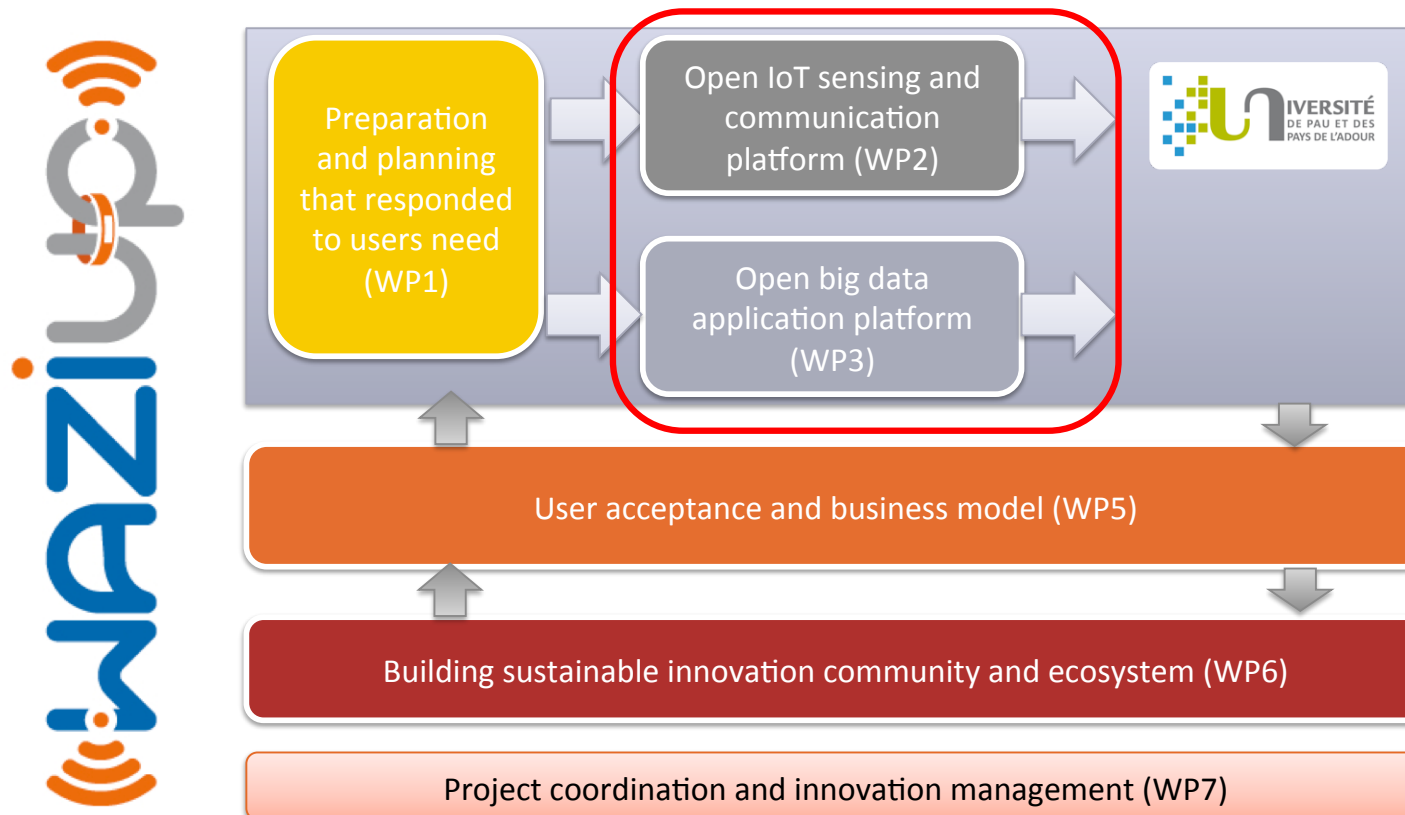
- FBK/CREATENET, Italy (Coordinator)**
- EASY GLOBAL MARKET, France**
- UNIVERSITY of PAU, France**
- UNPARALLEL INNOVATION, Portugal**
- INNOTEC21, Germany**
- UNIVERSITY GASTON BERGER, Senegal**
- CODER4AFRICA , Senegal**
- CTIC DAKAR, Senegal**
- UNIVERSITY of BOBO-DIOULASSO, Burkina-Faso**
- ISPACE, Ghana**
- FARMERLINE, Ghana**
- LAFRICAINE D'ARCHITECTURE, Togo**

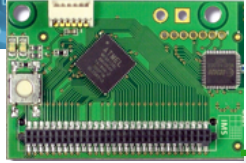


IoT FOR RURAL APPLICATIONS IN DEVELOPPING COUNTRIES

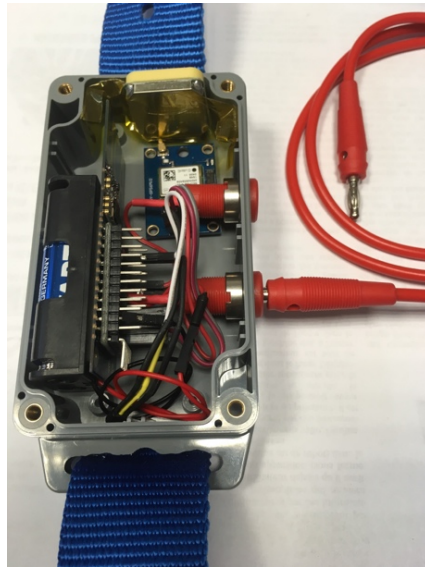


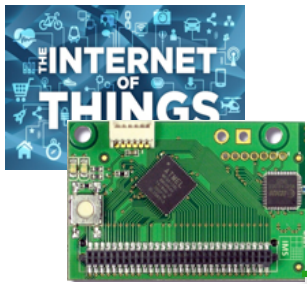
- ❑ WAZIUP is an EU H2020 project (2016-2019)
- ❑ contributes to long-range networks for rural applications with WP2 and big data with WP3





LOW-COST IOT DEVICES





LOW-COST HARDWARE INITIATIVE



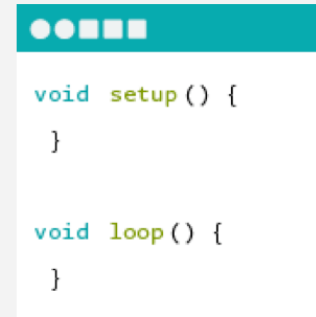
WHAT IS ARDUINO?

Arduino is an open-source electronics platform based on easy-to-use hardware and software. It's intended for anyone making interactive projects.



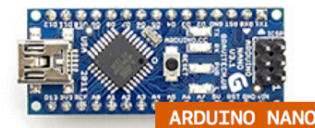
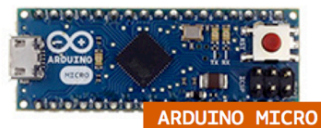
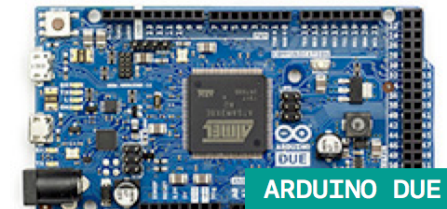
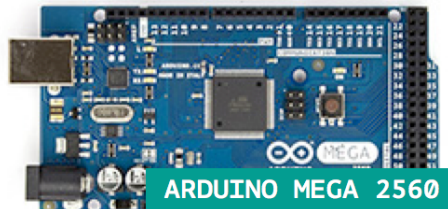
ARDUINO BOARD

Arduino senses the environment by receiving inputs from many sensors, and affects its surroundings by controlling lights, motors, and other actuators.



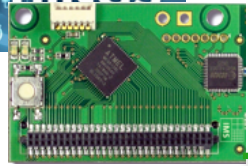
ARDUINO SOFTWARE

You can tell your Arduino what to do by writing code in the Arduino programming language and using the Arduino development environment.

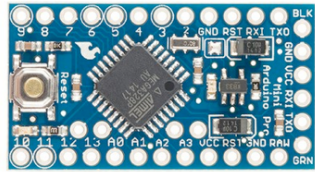




LARGE ECOSYSTEM, STILL GROWING...



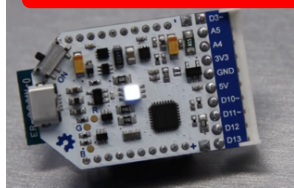
Arduino Pro Mini



LoPy

<http://blog.atmel.com/2015/12/16/rewind-50-of-the-best-boards-from-2015/>

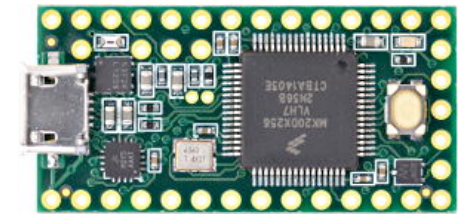
<http://blog.atmel.com/2015/04/09/25-dev-boards-to-help-you-get-started-on-your-next-iot-project/>



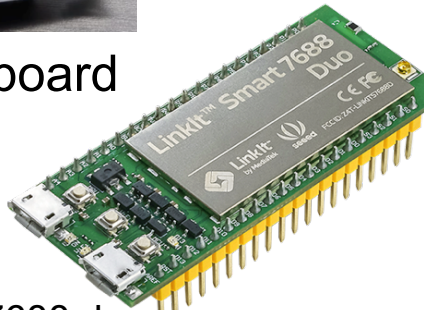
Theairboard



Expressif ESP32

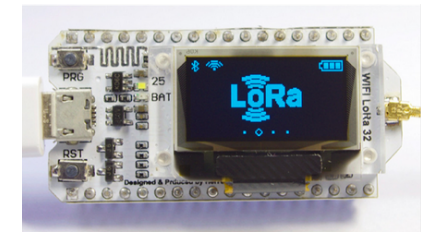
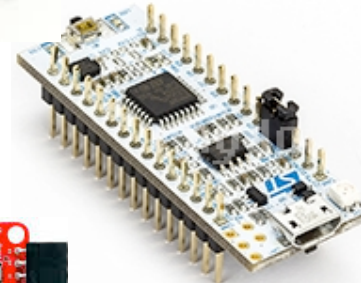


Teensy 3.2



LinkIt Smart7688 duo

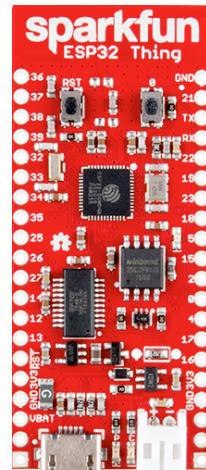
STM32 Nucleo-32



Heltec ESP32 + OLED



Adafruit Feather



Sparkfun ESP32 Thing

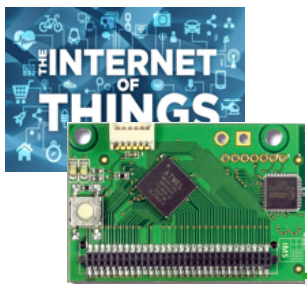


Tessel

SodaqOnev2



Tinyduino



... STIMULATING "DO-IT-YOURSELF" WORLDWIDE

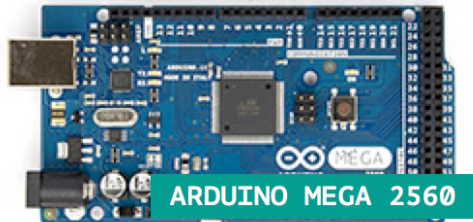


- DIY usually means
 - More open-source software from larger community
 - More flexibility

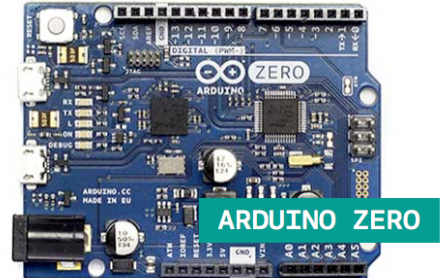
WAZIUP PROVIDES SW/HW BUILDING BLOCKS INTEGRATION



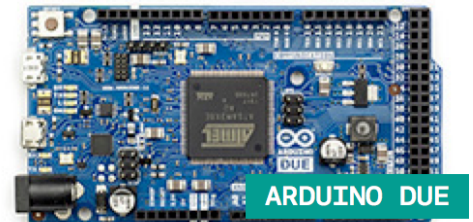
ARDUINO UNO



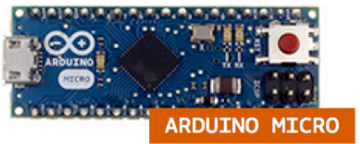
ARDUINO MEGA 2560



ARDUINO ZERO



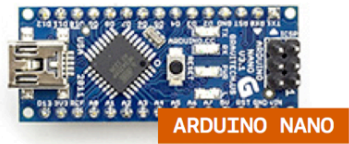
ARDUINO DUE



ARDUINO MICRO



ARDUINO PRO MINI



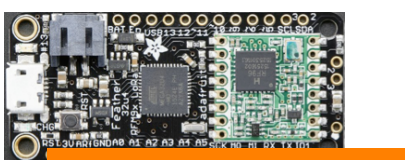
ARDUINO NANO



Ideetron Nexus



TeensyLC/3.1/3.2



Adafruit Feather 32u4/M0



Expressif ESP8266/ESP32

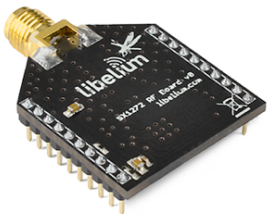
More to come...



LoRa radios that our library already supports



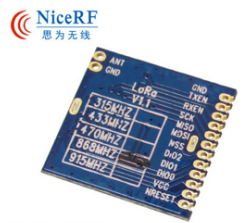
HopeRF RFM92W/95W



Libelium LoRa



Modtronix inAir9/9B



LoRa1276 NiceRF LoRa1276

Long-Range communication library



WAZIUP PROPOSES 100% OPEN-SOURCE SOFTWARE



```
Arduino_LoRa_temp | Arduino 1.6.6
Arduino_LoRa_temp
* temperature sensor on analog 8 to test the LoRa gateway
* Copyright (C) 2015 Congduc Pham, University of Pau, France
* This program is free software: you can redistribute it and/or modify
* it under the terms of the GNU General Public License as published by
* the Free Software Foundation, either version 3 of the License, or
* (at your option) any later version.
* This program is distributed in the hope that it will be useful,
* but WITHOUT ANY WARRANTY;
* MERCHANTABILITY or FITNESS
* GNU General Public License
* You should have received
* along with the program.
* .....
// Include the SX1272
#include "SX1272.h"
// IMPORTANT
// please uncomment only 1 ch
// it seems that both HopeRF
// boards we set the initial
//
// uncomment if your radio is
#define RADIO_RF92_95
// uncomment if your radio is
#define RADIO_INA1R98
// IMPORTANT
```

CongducPham / LowCostLoRaGw

Watch 50 Star 161 Fork 95

Code Issues 62 Pull requests 2 Projects 0 Pulse Graphs

Low-cost LoRa IoT & gateway with SX1272/76, Raspberry and Arduino

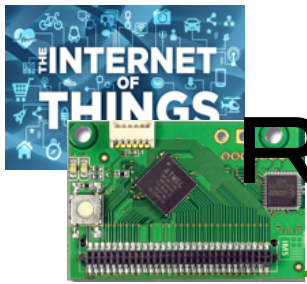
122 commits 1 branch 0 releases 2 contributors

Branch: master New pull request Find file Clone or download

Congduc Pham bug fix in lora_gateway.cpp Latest commit a0daa4a a day ago

Arduino	update SMS scripts	15 days ago
gw_full_latest	bug fix in lora_gateway.cpp	a day ago
tutorials	update SMS scripts	15 days ago
.gitignore	.DS_Store banished	10 months ago
README.md	update README	11 days ago

LowCostLoRaGw github has latest general distribution:
<https://github.com/CongducPham/LowCostLoRaGw>
WAZIUP-specific configuration can be found on
<https://github.com/Waziup/waziup-gateway>



READY-TO-USE TEMPLATES



Moisture/
Temperature of
storage areas



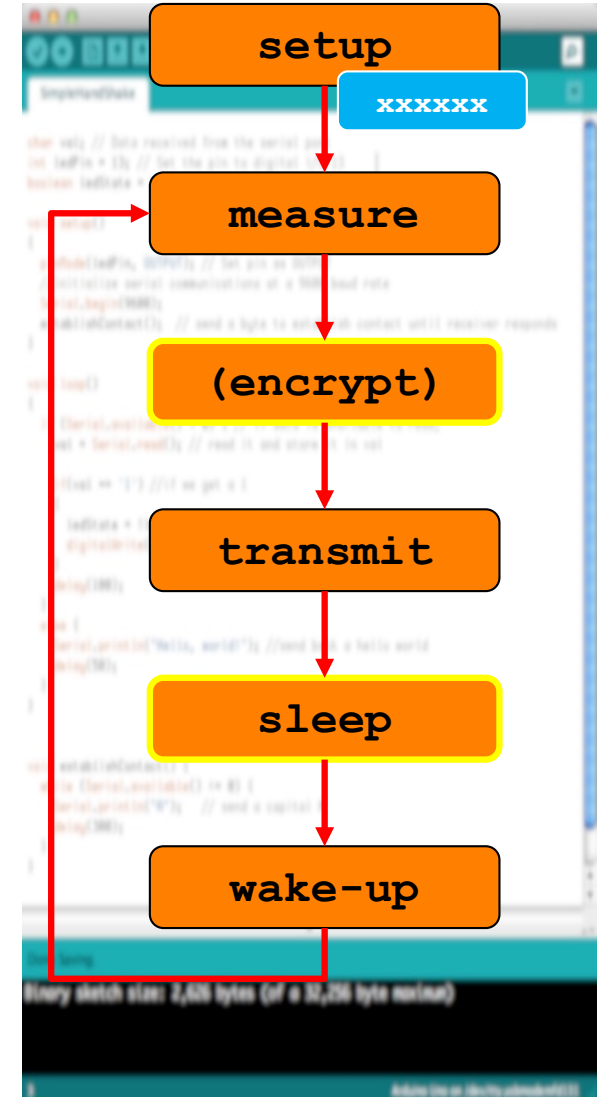
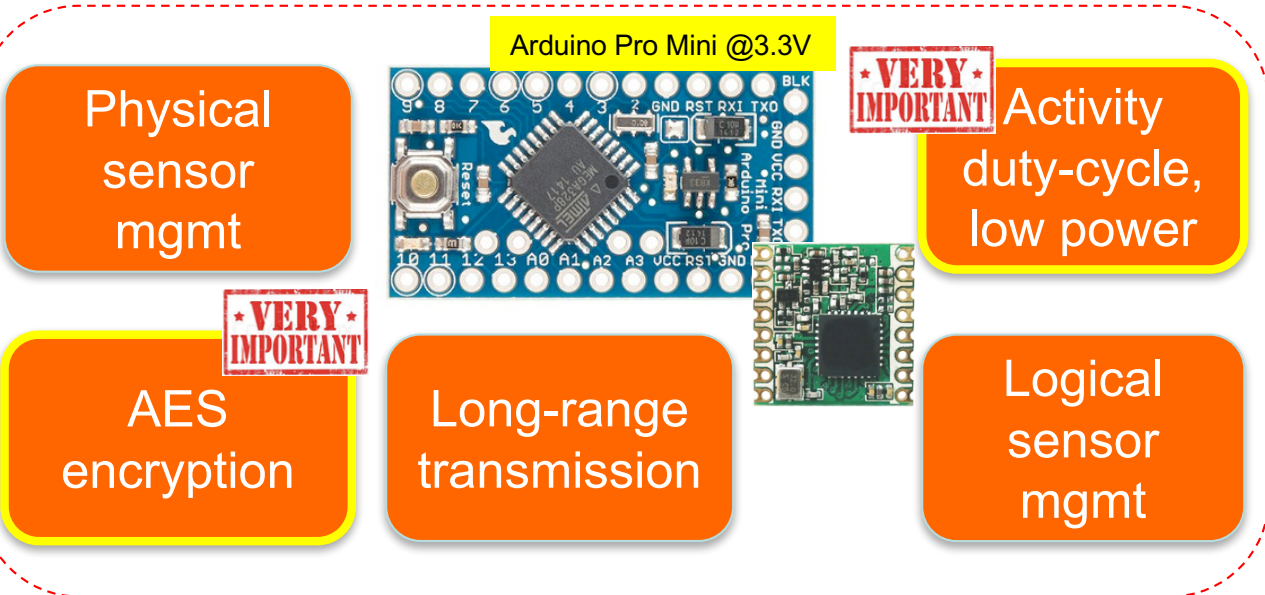
10-15kms

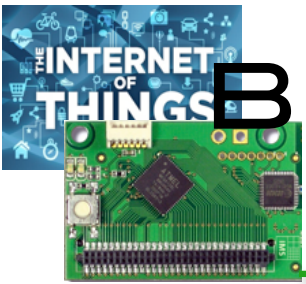


Physical
sensor

Physical
sensor

Physical
sensor





BUILD YOUR FIRST LORA IOT DEVICE



```

Arduino  File  Edit  Sketch  Tools  Help
  Auto Format ⌘T
  Archive Sketch
  Fix Encoding & Reload
  Serial Monitor ⌘M
  Serial Plotter ⌘L

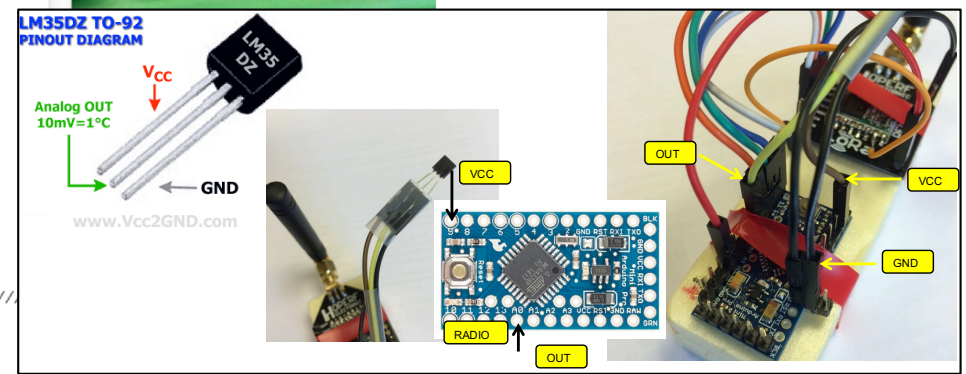
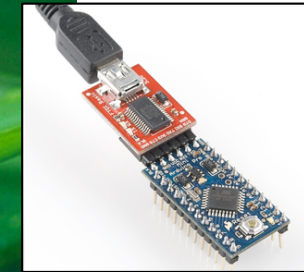
  Board: "Arduino Pro or Pro Mini"
  Processor: "ATmega168 (3.3V, 8 MHz)"
  Port
  Programmer: "AVRISP mkII"
  Burn Bootloader

  Serial ports
  /dev/cu.Bluetooth-Modem
  /dev/cu.Bluetooth-PDA-Sync
  /dev/cu.usbmodem1427871

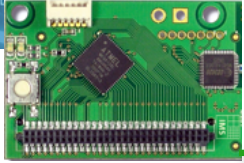
  Arduino_LoRa_temp
  /*
   * temperature sensor on analog 8 to t
   * Copyright (C) 2015 Congduc Pham, Un
   *
   * This program is free software: you
   * it under the terms of the GNU Gener
   * the Free Software Foundation, eithe
   * (at your option) any later version.
   *
   * This program is distributed in the hope that it will be useful,
   * but WITHOUT ANY WARRANTY; without even the implied warranty of
   * MERCHANTABILITY or FITNESS FOR A PARTICULAR PURPOSE.  See the
   * GNU General Public License for more details.
   *
   * You should have received a copy of the GNU General Public License
   * along with the program.  If not, see <http://www.gnu.org/licenses/>.
   *
   * *****
   */

  // Include the SX1272
  #include "SX1272.h"

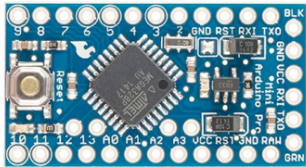
  // IMPORTANT
  // //////////////////////////////////////
  // please uncomment only 1 choice
  //
  
```



Connect the USB end to your computer and the USB port should be detected in the Arduino IDE. Select the serial port for your device. It may have another name than what is shown in the example. Then click on the « upload » button

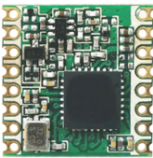


LOW-COST INTEGRATION

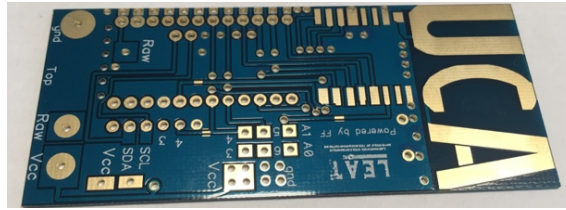


1.5€

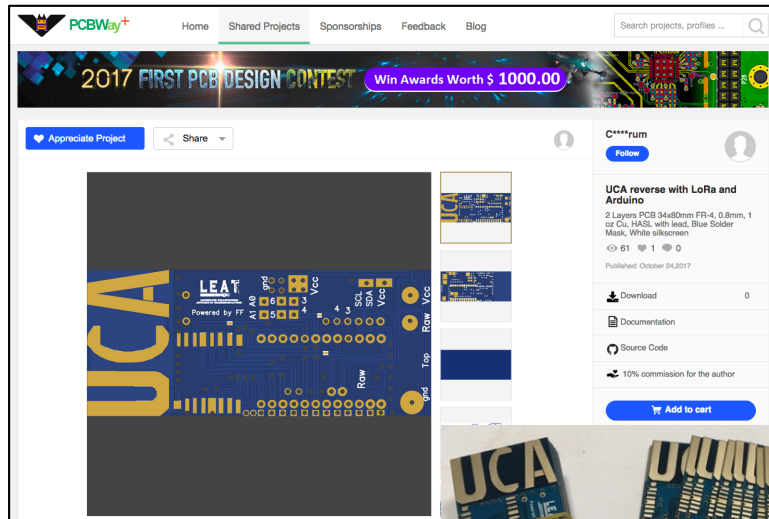
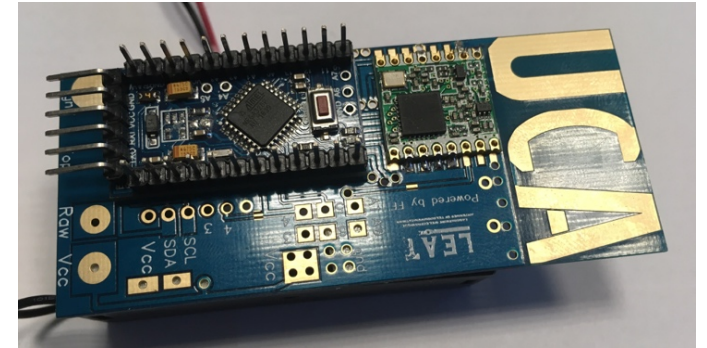
https://github.com/FabienFerrero/UCA_Board



5€

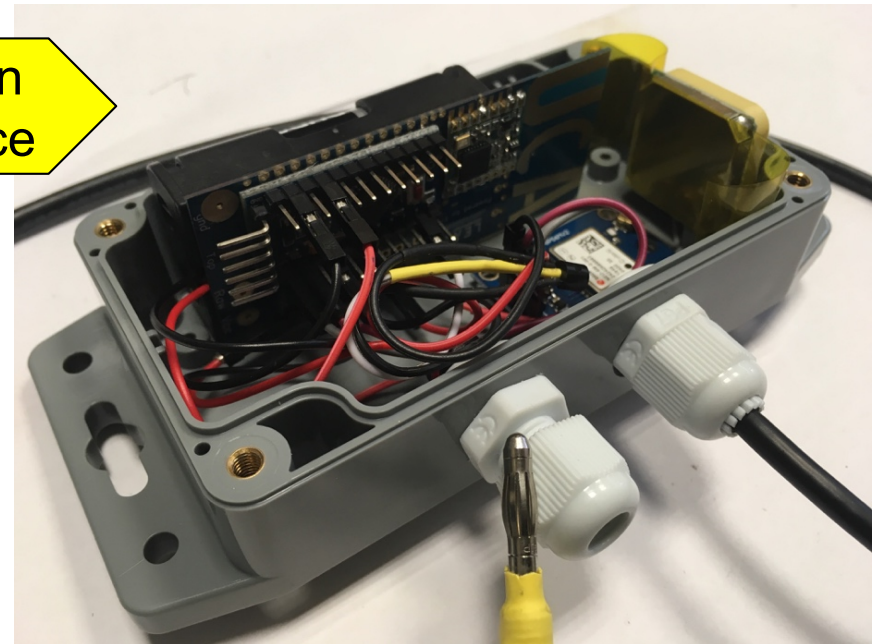
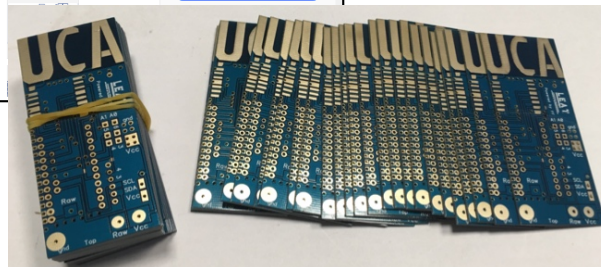


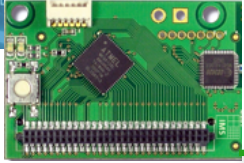
1€



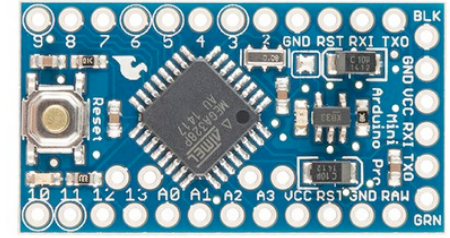
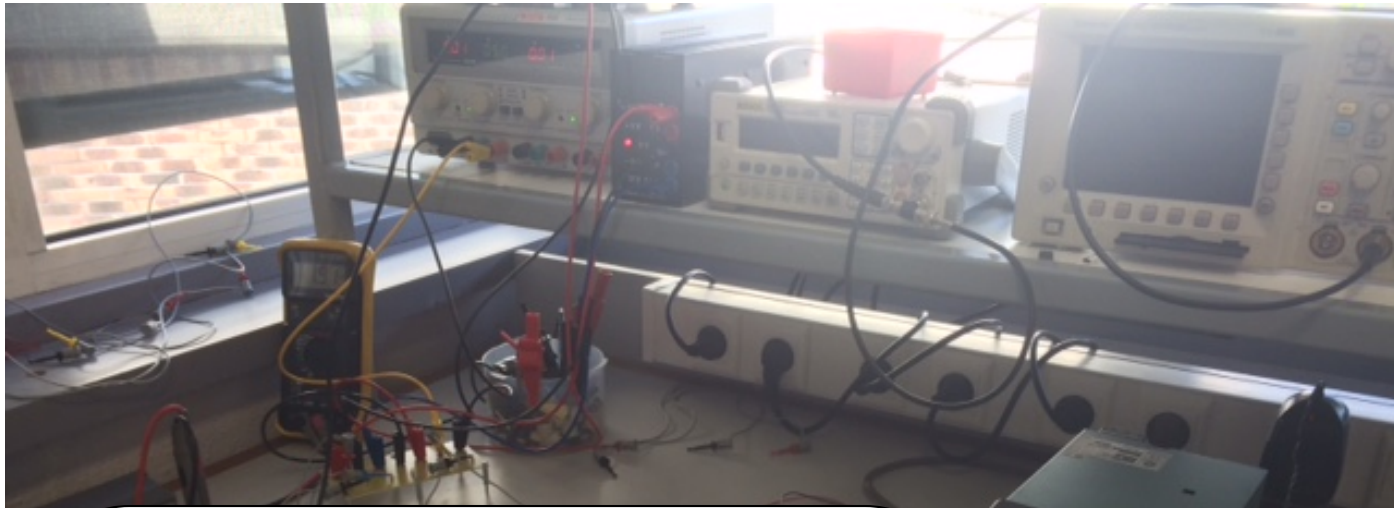
Less than 10€/device

1-click order

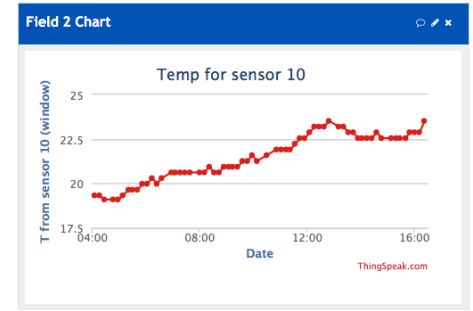




LOW-POWER FOR LONGER LIFETIME!

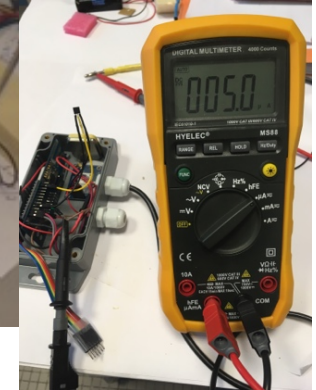


Wakes-up every 10min, take a measure (temp) and send to GW

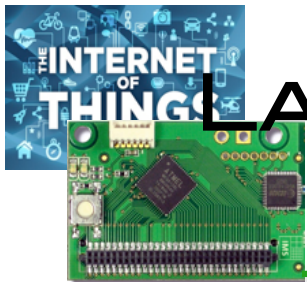


2500mAh

Can run more than 1 year with 1 measure/10min
Can run several years with 1 measure/1h



5 μ A in deep sleep mode, about 40mA when active and sending!



LARGE VARIETY OF EXAMPLES TO LEARN AND ADAPT



CongducPham / LowCostLoRaGw

Unwatch 49 Unstar 216 Fork 120

Code Issues 96 Pull requests 2 Projects 0 Wiki Insights Settings

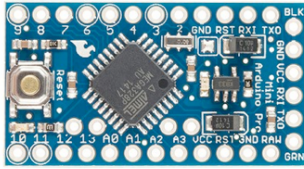
Branch: master LowCostLoRaGw / Arduino / Create new file Upload files Find file History

Congduc Pham update README files, fix MD5 digest computation of gw id, always use ... Latest commit aba3ed2 2 days ago

..		
Arduino_LoRa_GPS	update README	19 days ago
Arduino_LoRa_Gateway	update gateway related files and some sketch	4 months ago
Arduino_LoRa_Gateway_1_4	improve management of transmission power, add channels in 863-865	a year ago
Arduino_LoRa_Generic_Sensor	update Arduino examples	a month ago
Arduino_LoRa_InteractiveDevice	update Arduino examples	a month ago
Arduino_LoRa_Ping_Pong	update Arduino examples	a month ago
Arduino_LoRa_Simple_BeaconCol...	update Arduino example	23 days ago
Arduino_LoRa_Simple_SoilHum	update Arduino examples	a month ago
Arduino_LoRa_Simple_temp	update Arduino examples	a month ago
Arduino_LoRa_SoilHum	update Arduino examples	a month ago
Arduino_LoRa_temp	update Arduino examples	a month ago
Arduino_LoRa_ucamII	update image support	3 months ago
libraries	update README files, fix MD5 digest computation of gw id, always use ...	2 days ago
README.md	update README	19 days ago

THE SIMPLE TEMPERATURE SENSOR EXAMPLE

Arduino Pro Mini @3.3V



Modtronix inAir9



TMP36








TUTORIALS AND VIDEOS

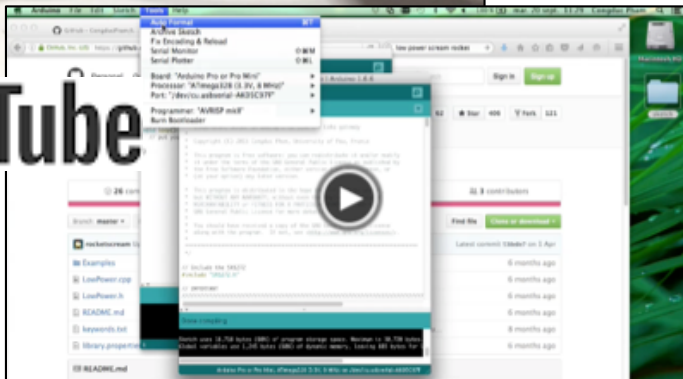
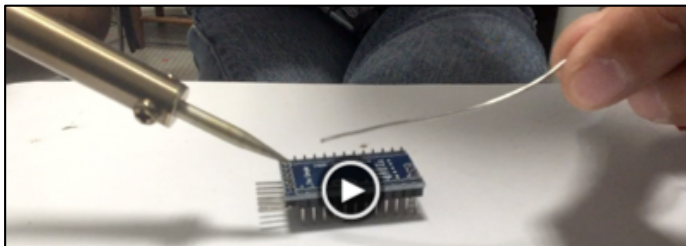




**LOW-COST LORA IOT DEVICE:
A STEP-BY-STEP TUTORIAL**



PROF. CONGDUC PHAM
[HTTP://WWW.UNIV-PAU.FR/~CPHAM](http://www.univ-pau.fr/~cpham)
 UNIVERSITÉ DE PAU, FRANCE



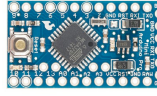

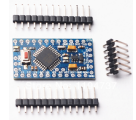

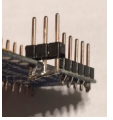



Congduc Pham, <http://cpham.perso.univ-pau.fr>
<http://www.waziup.eu>

The generic hardware platform

The Arduino Pro Mini

The Arduino Pro Mini is a compact form factor Arduino board based on the ATmega328P microcontroller. Use the **3.3v and 8MHz version** of the Arduino Pro Mini for lower power consumption.








You can get the original board designed by Sparkfun or get one of the various clones available mainly from Chinese manufacturer. The last solution is very cost-effective as the Pro Mini board can be purchased for a bit more than 1€ a piece.


Depending on how many sensors you want to connect, the number of ground (GND) pins may be limited. You can extend a GND pin with a header pin where all pins are soldered together.

The LoRa radio module


There are various LoRa radio modules that are all based on the Semtech SX1272/1276 chips family.




Fully tested LoRa radio modules



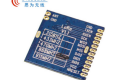
HopeRF RFM92W/95W



Libelium LoRa



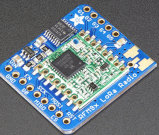

Modtronix inAir4/9/9B



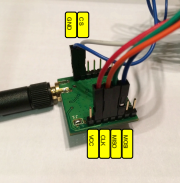
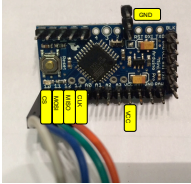
NiceRF LoRa1276

Most of SPI-based LoRa radio modules are supported. We recommend the Modtronix inAir model if you don't have delicate soldering experience as this module can come with header pins ready to be connected with Dupont wires.

The RFM95W can be found assembled (Adafruit) or an adapter can be purchased (from Ideetron for instance).

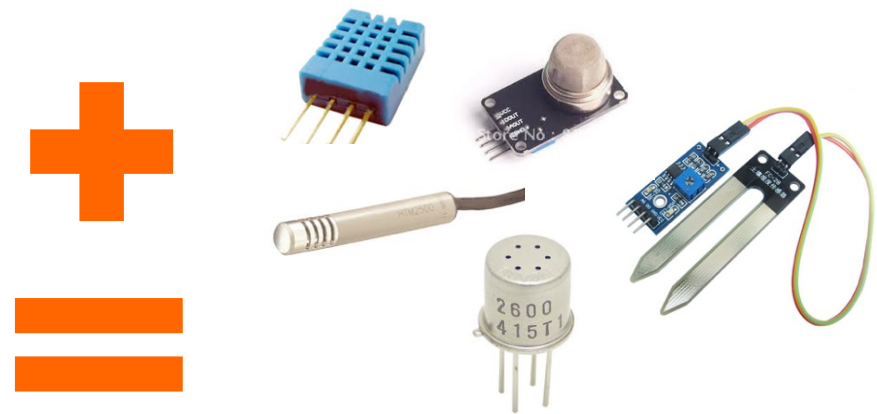
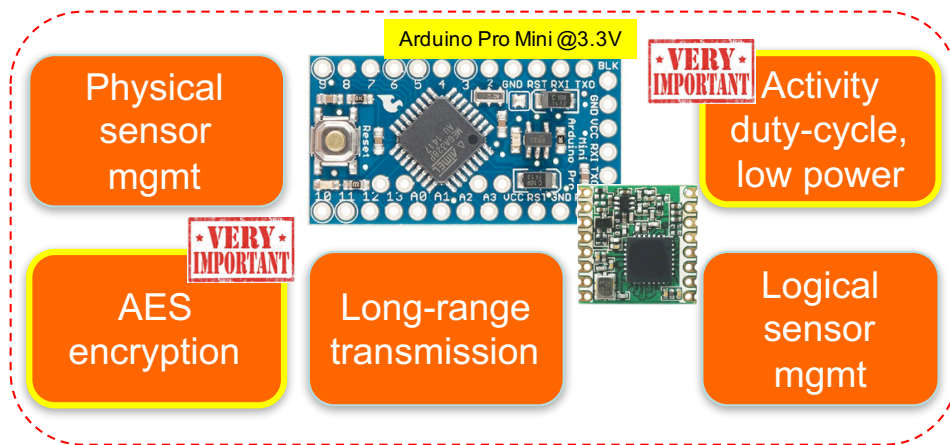
Connect the LoRa radio module

Connect the corresponding SPI pins of the radio module to the SPI pins on the Pro Mini board. MOSI (blue) is pin 11, MISO (green) is pin 12, CS (white) is pin 10 and CLK (orange) is pin 13 (right picture). Then connect also the VCC (red) and the GND (black) of the radio module to the VCC and the GND of the board (right picture). The VCC of the Pro Mini board gets 3.3v from the on-board voltage regulator.

GENERIC SENSING IOT DEVICE

- ❑ Build low-cost, low-power, Long-range enabled generic platform
- ❑ Methodology for low-cost platform design
- ❑ Technology transfers to user communities, economic actors, stakeholders,...



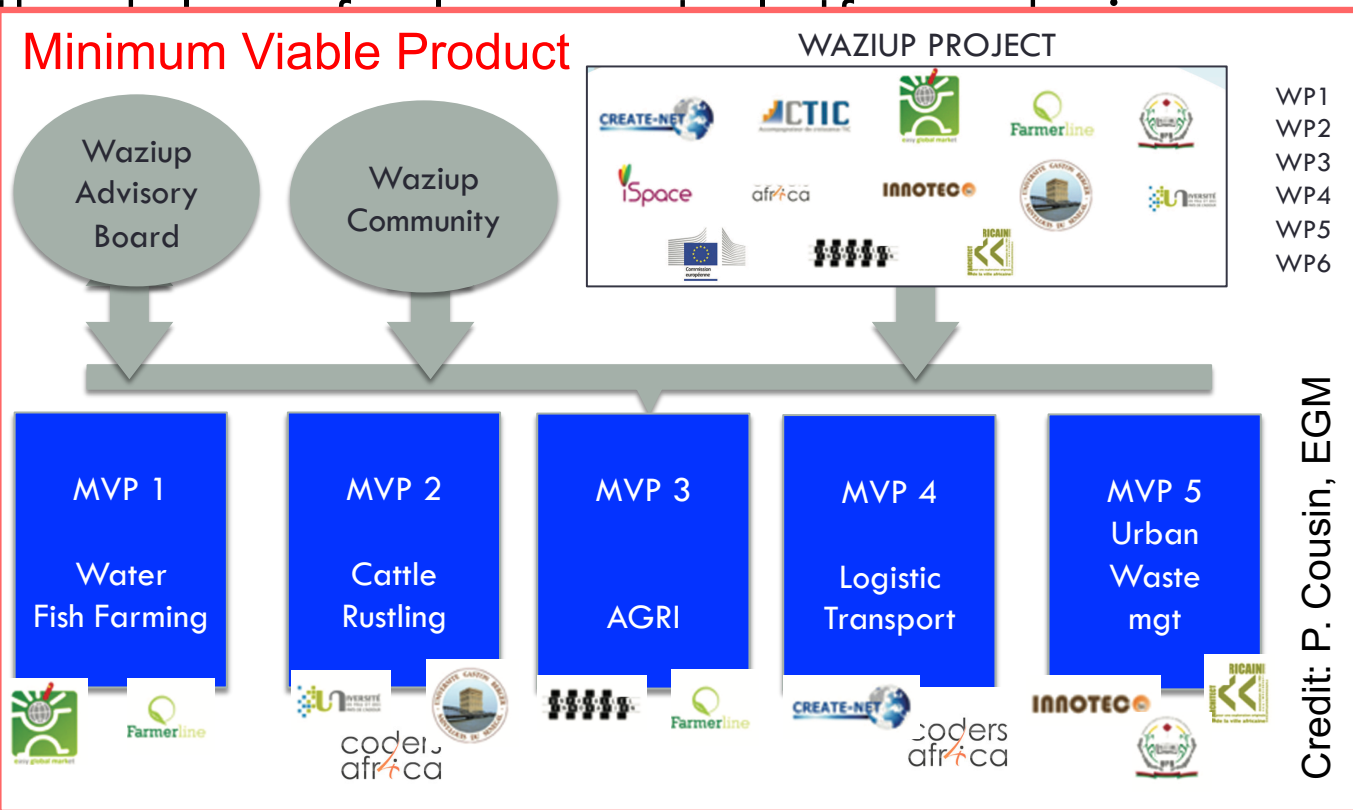


GENERIC SENSING IOT DEVICE



- ❑ Build low-cost, low-power, Long-range enabled generic platform
- ❑ Meet the needs of the African continent
- ❑ Technical and economic viability

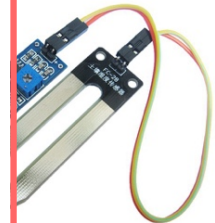
Minimum Viable Product



Physical sensor mgmt

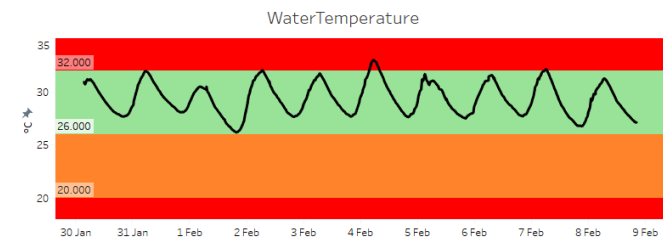
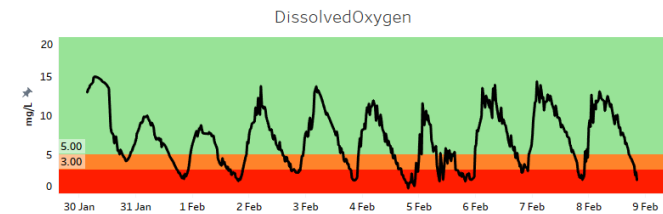
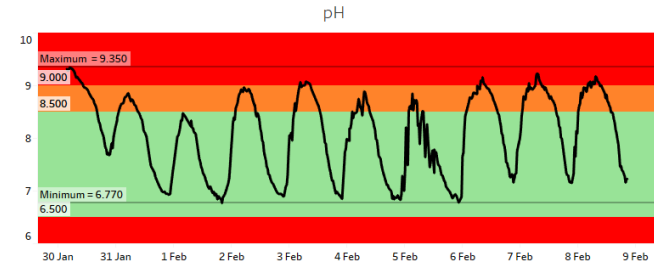
AES encryption

VERY IMPORTANT



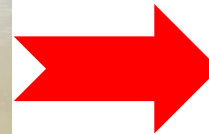
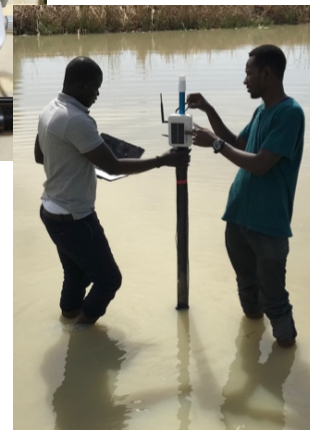


LOW-COST BUOY FOR FISH FARMING MVP

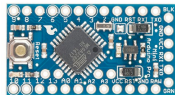


Physical sensor reading

Credit: EGM



Physical sensor management

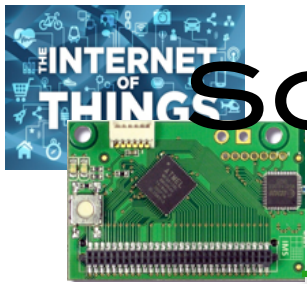


Activity duty-cycle, low power

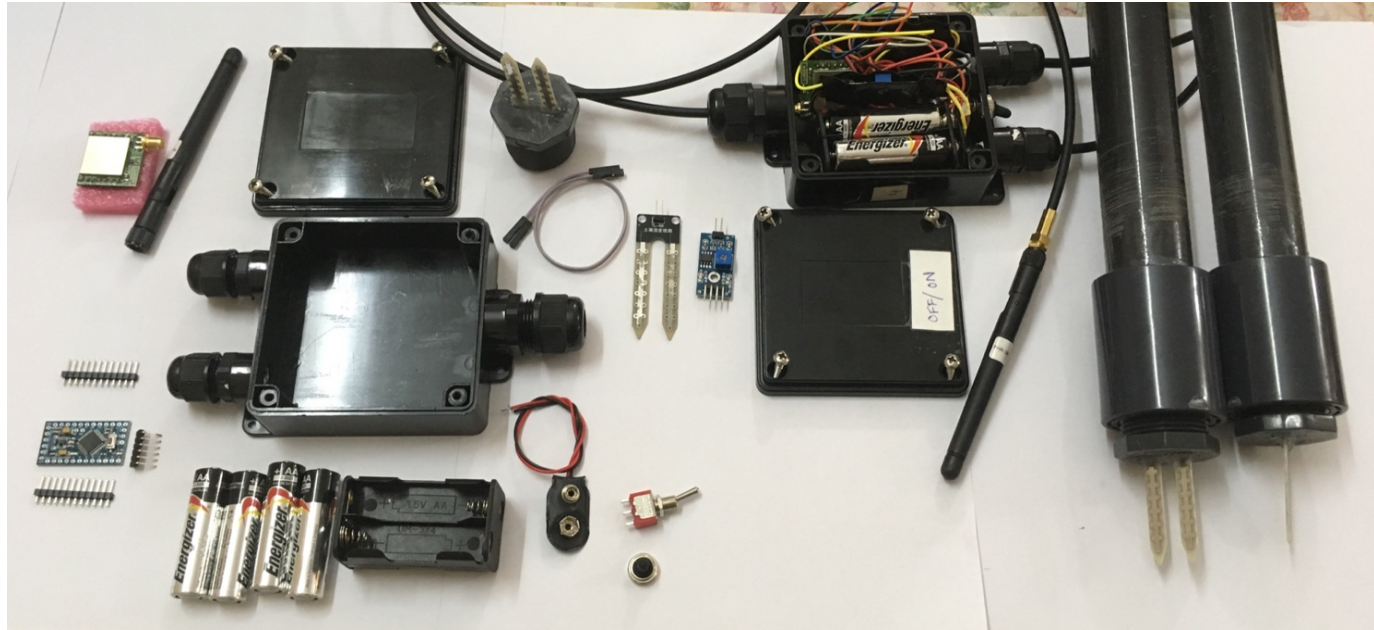
Security

Long-range transmission

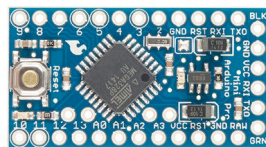
Logical sensor management



SOIL HUMIDITY SENSORS FOR AGRI MVP



Physical sensor management



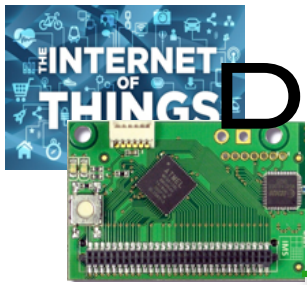
Activity duty-cycle, low power

Security

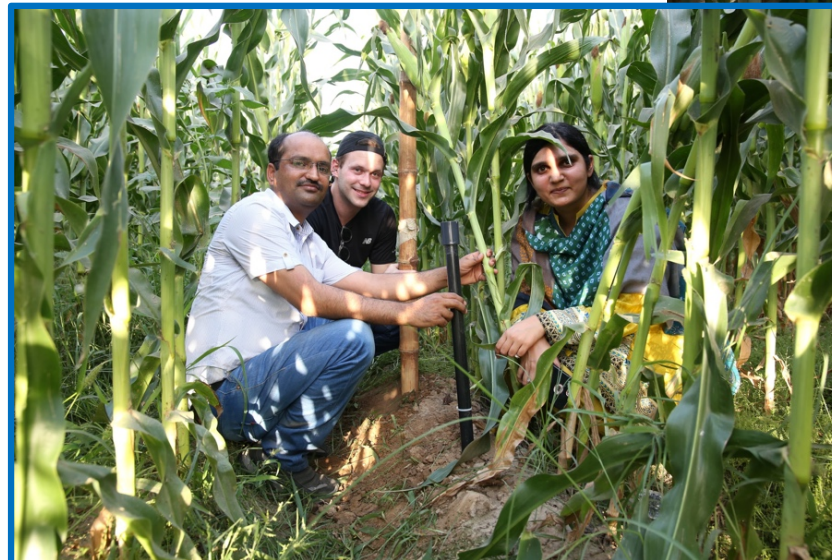
Long-range transmission

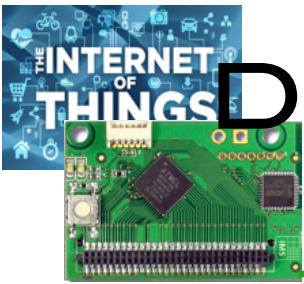
Logical sensor management



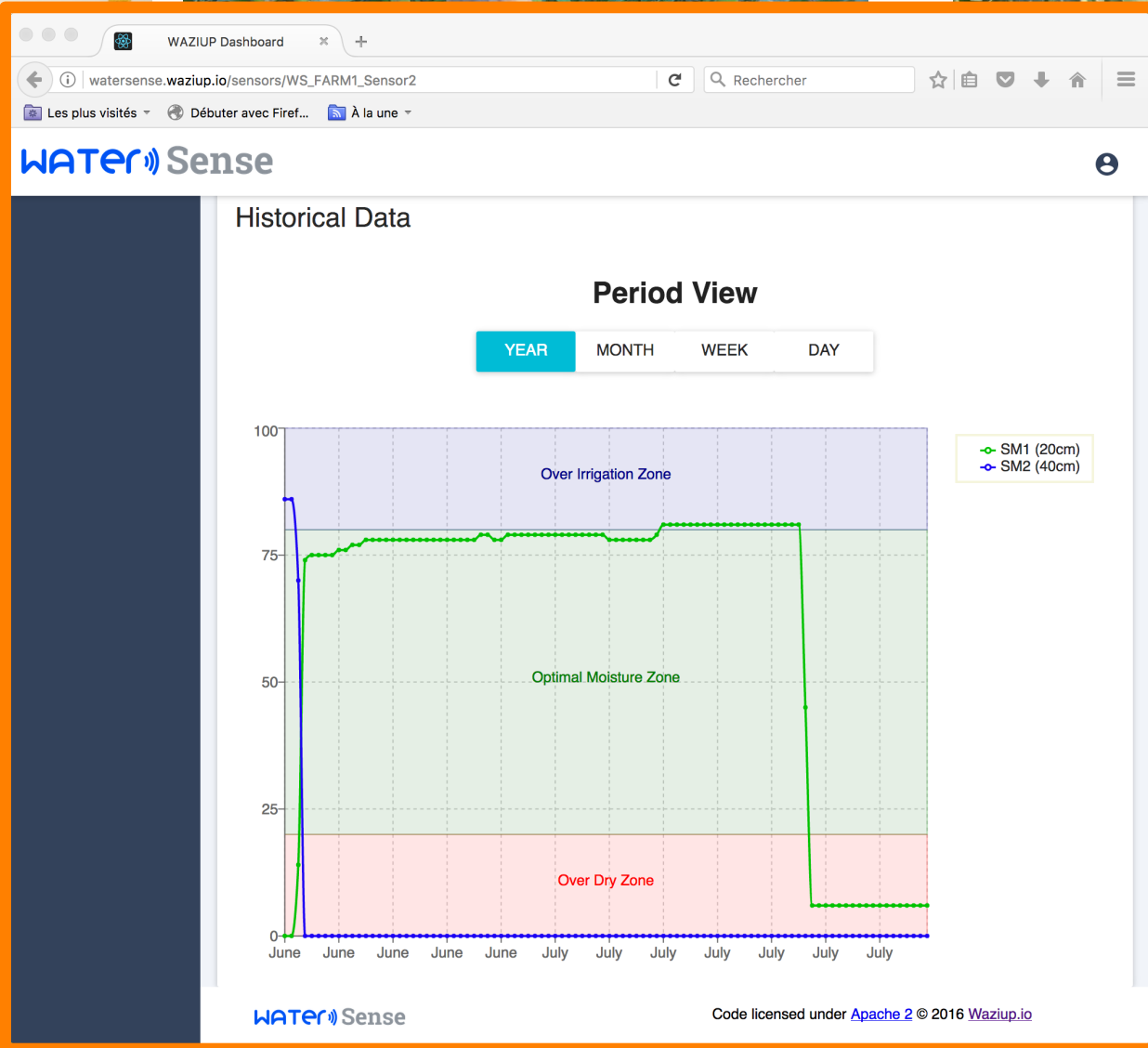


DEPLOYMENT FOR NESTLÉ'S WATERSENSE PROJECT



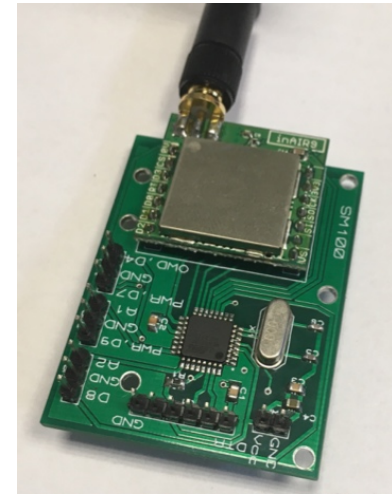
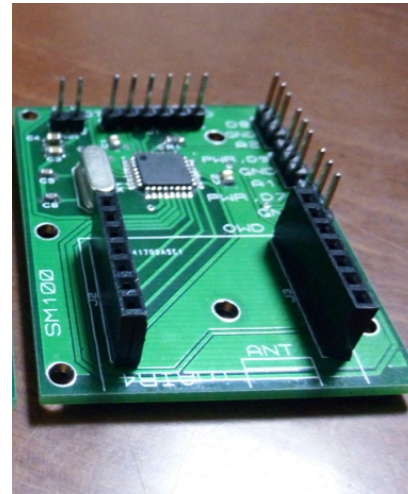
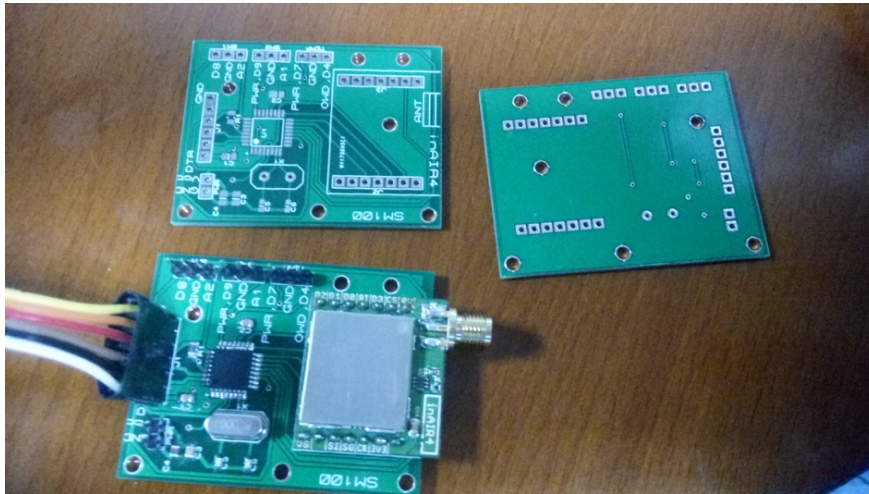


DEPLOYMENT FOR NESTLÉ'S WATERSENSE PROJECT





LOCAL INTEGRATION WITH TECHNOLOGY TRANSFER





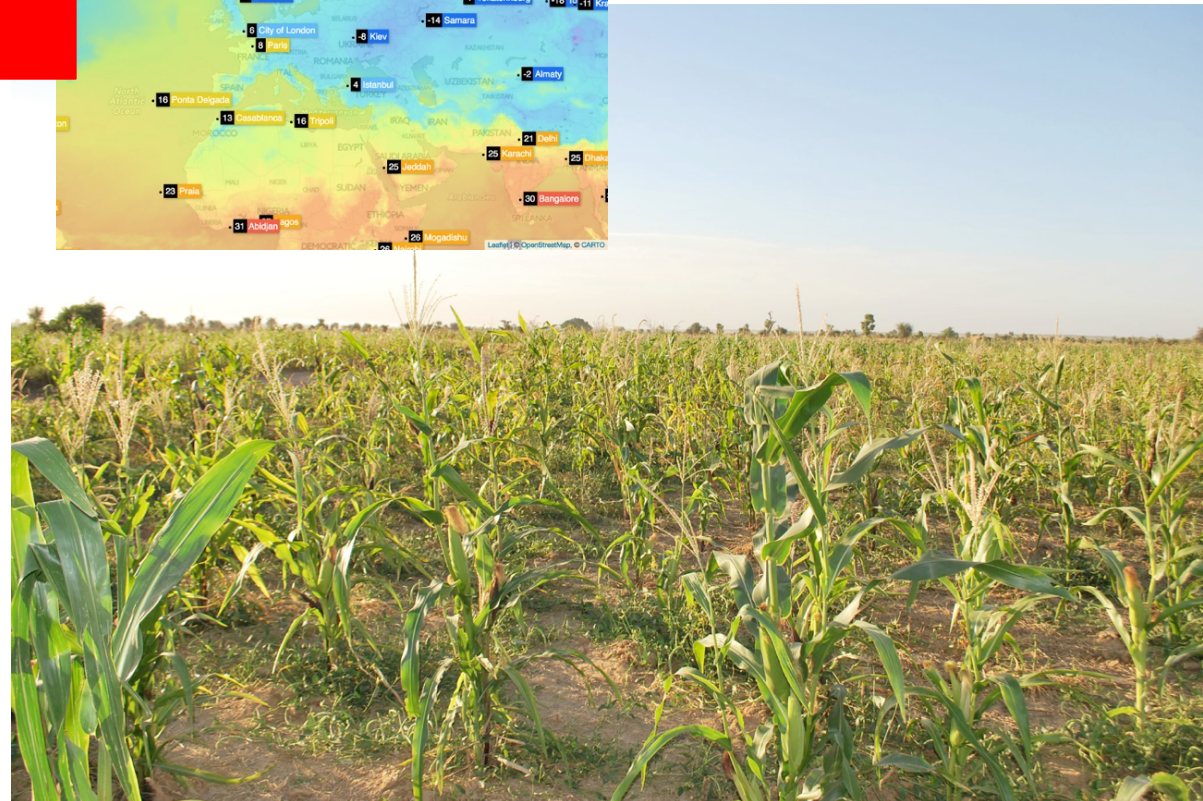
LOCAL WEATHER STATION FOR AGRI MVP



<https://openweathermap.org/>

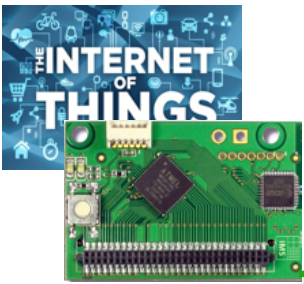


Photo from Unparallel

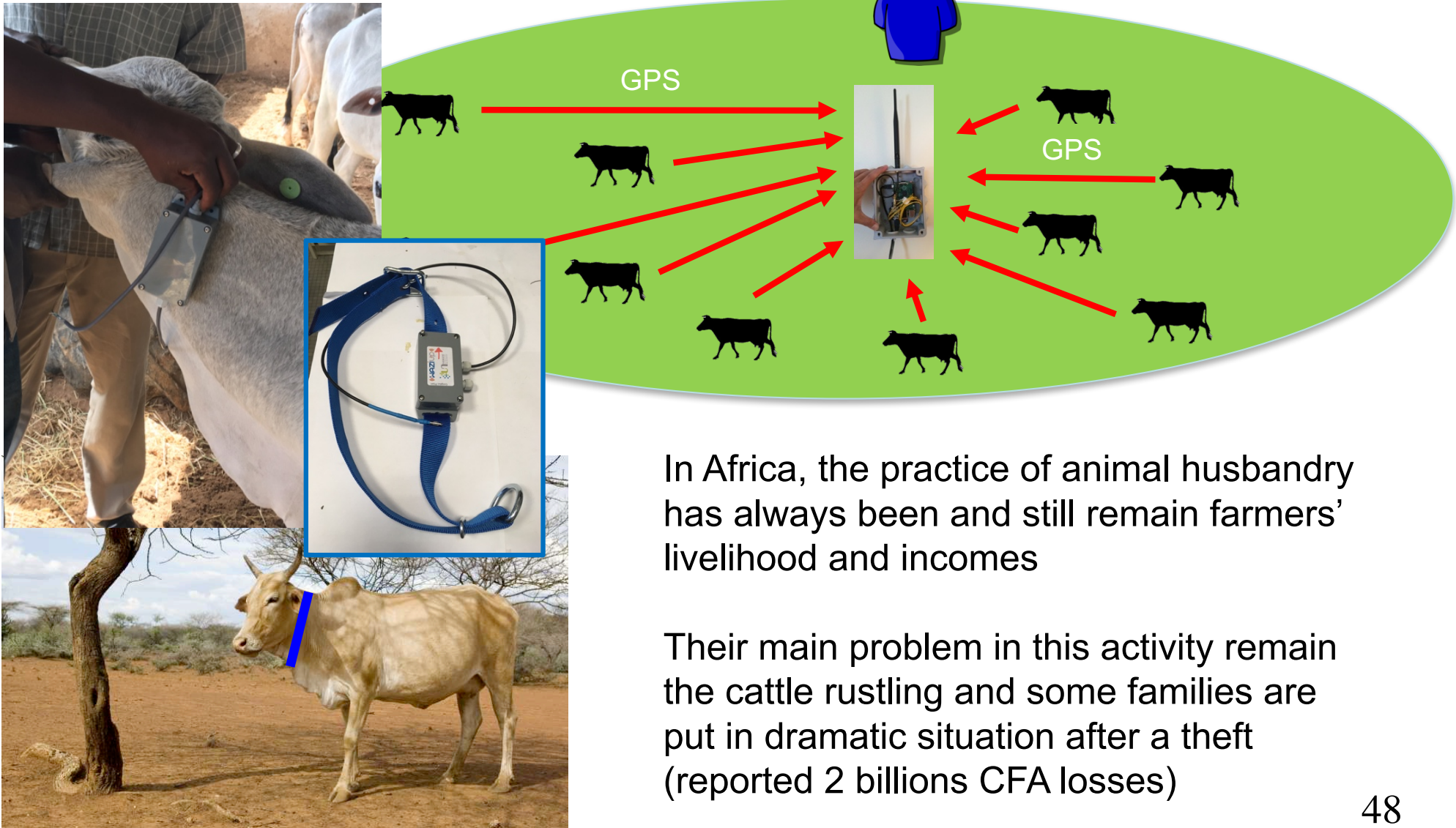


Get local weather measurements

Combine with open weather data to get more accurate predictions



COLLAR FOR CATTLE RUSTLING MVP

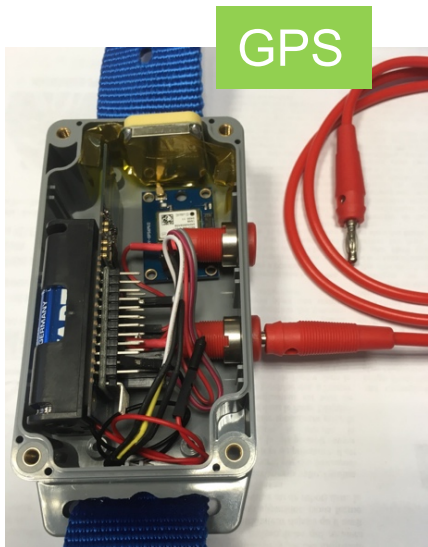
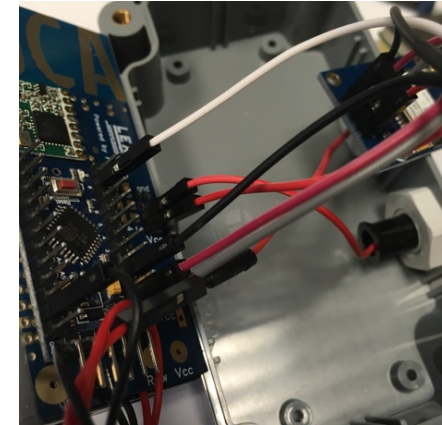
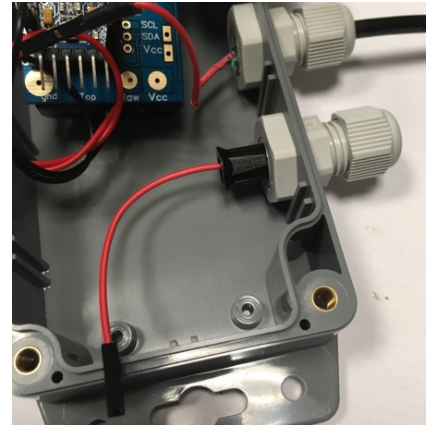
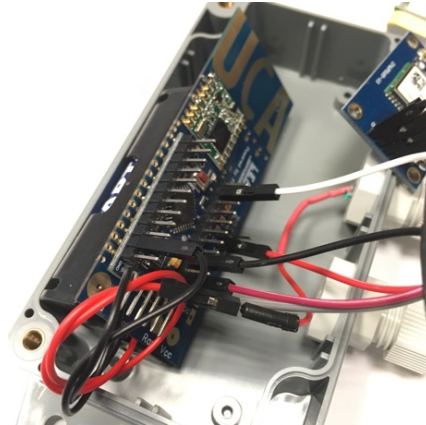
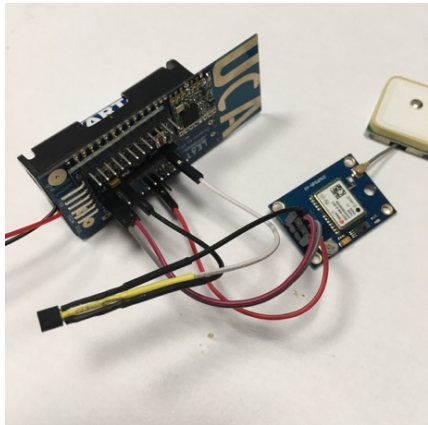


In Africa, the practice of animal husbandry has always been and still remain farmers' livelihood and incomes

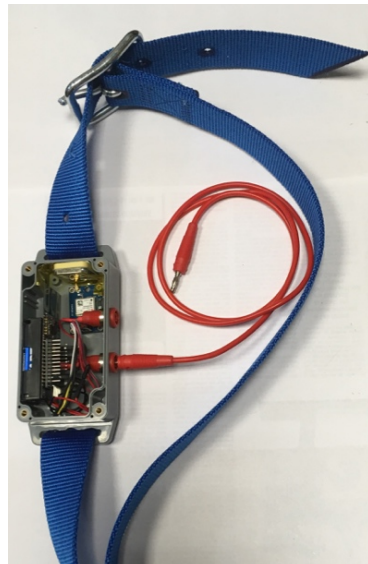
Their main problem in this activity remain the cattle rustling and some families are put in dramatic situation after a theft (reported 2 billions CFA losses)



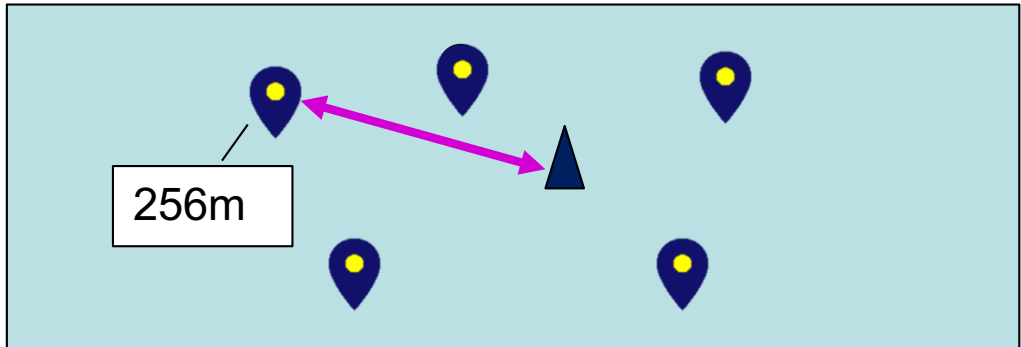
EASY INTEGRATION AND CUSTOMIZATION



GPS

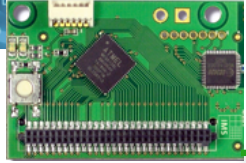


A web interface can be developed to display the position of the gateway and the position of the remote GPS devices

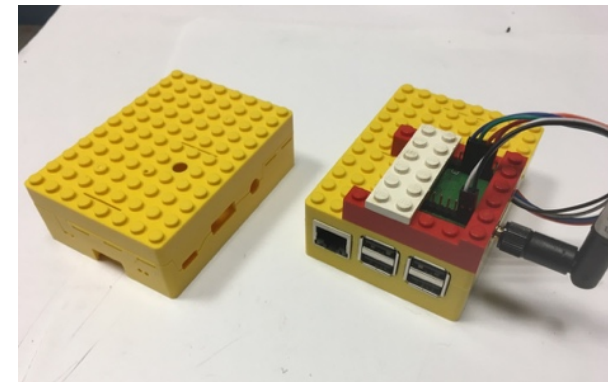
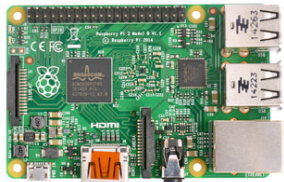


Dedicated tutorial on low-cost IoT collar w/GPS

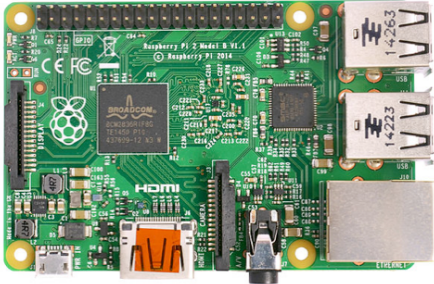
<https://github.com/CongducPham/tutorials/blob/master/Low-cost-LoRa-Collar.pdf>



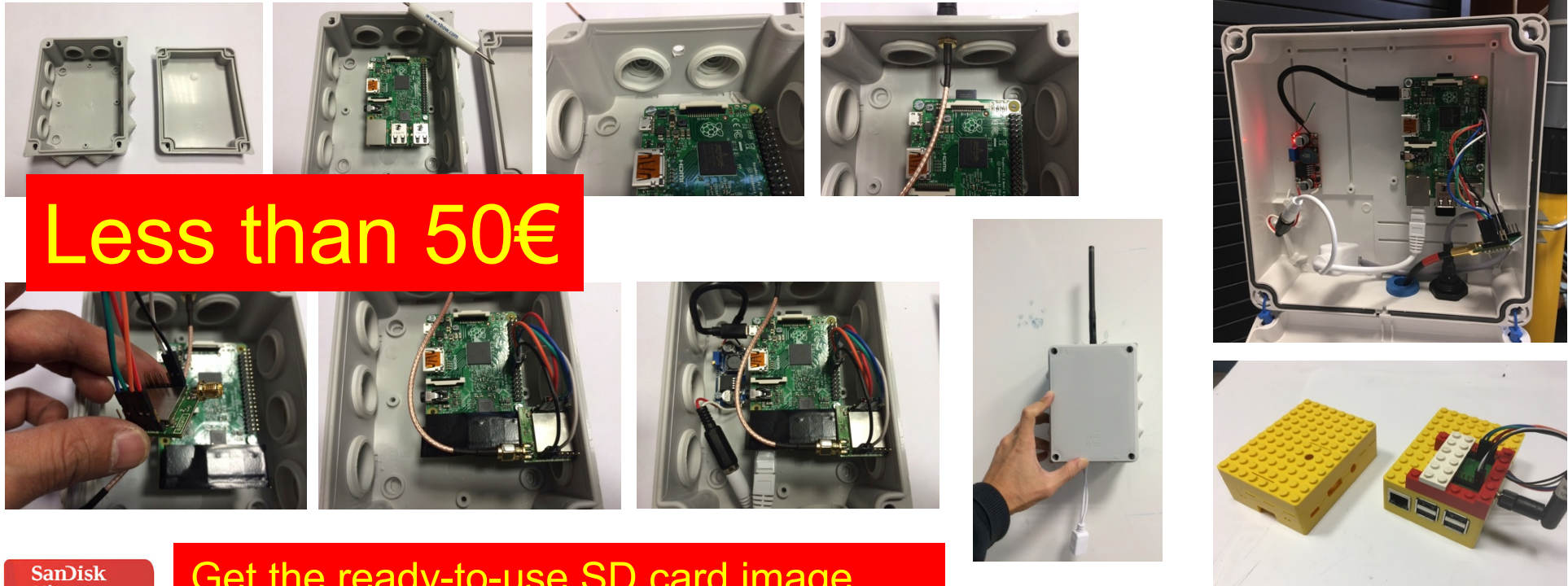
THE VERSATILE IOT GATEWAY



RASPBERRY-BASED LOW-COST LORA GATEWAY



We can use all model of Raspberry. The most important usefull feature is the Ethernet interface for easy Internet connection. Then WiFi and Bluetooth can be added with USB dongles. RPI3 provides built-in Ethernet, WiFi and Bluetooth!

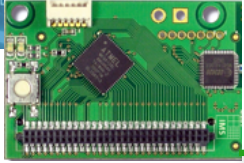


Less than 50€

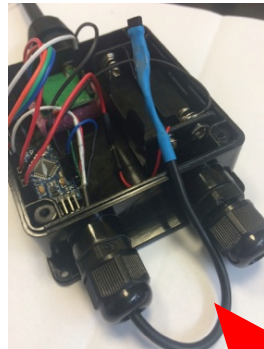
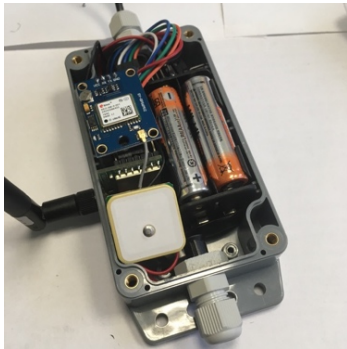


Get the ready-to-use SD card image

<http://cpham.perso.univ-pau.fr/LORA/WAZIUP/raspberrypi-jessie-WAZIUP-demo.dmg.zip>



100% DO-IT-YOURSELF !



Step-by-step tutorial and source code available

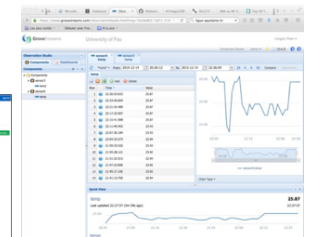
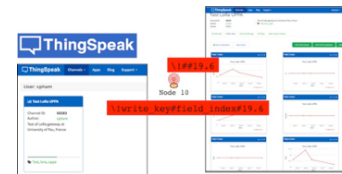


Step-by-step tutorial and source code available

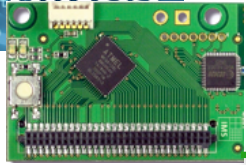
Python scripts available



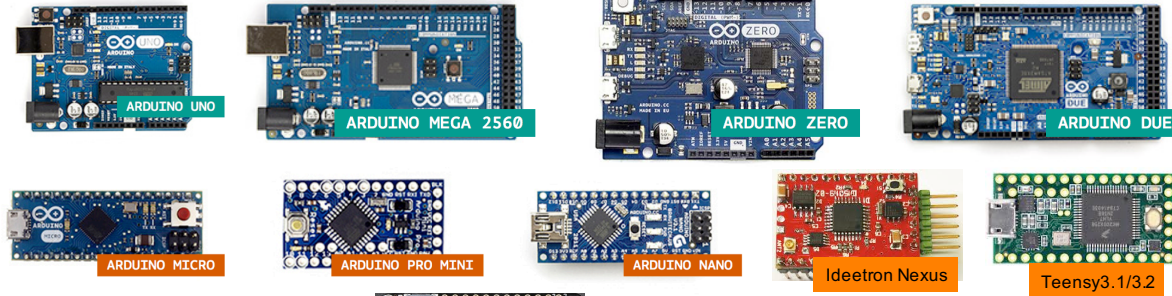
freeboard



<https://github.com/CongducPham/LowCostLoRaGw>

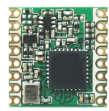


SIMPLICITY!



More to come...

LoRa™
LoRa radios that our library already supports



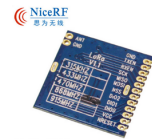
HopeRF RFM92W/95W



Libelium LoRa



Modtronix inAir4/9/9B



LoRa1276 NiceRF LoRa1276

Long-Range communication library



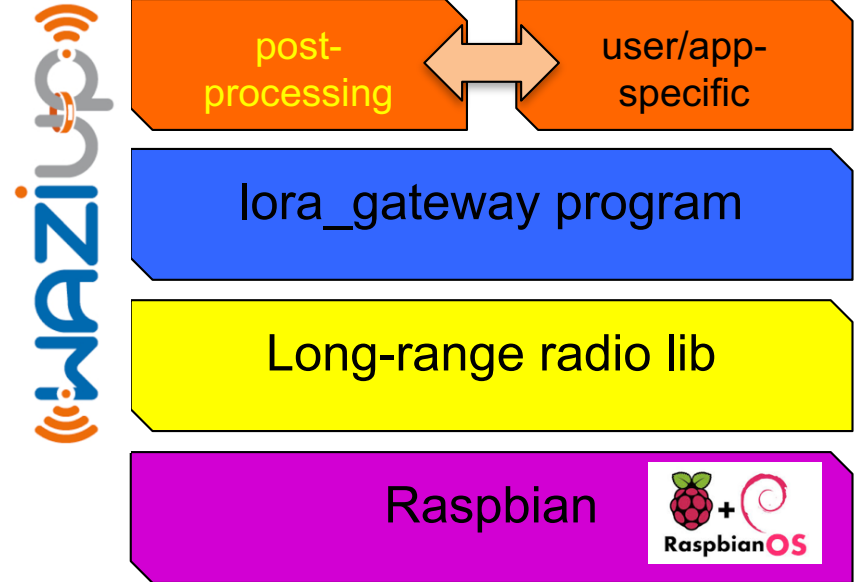
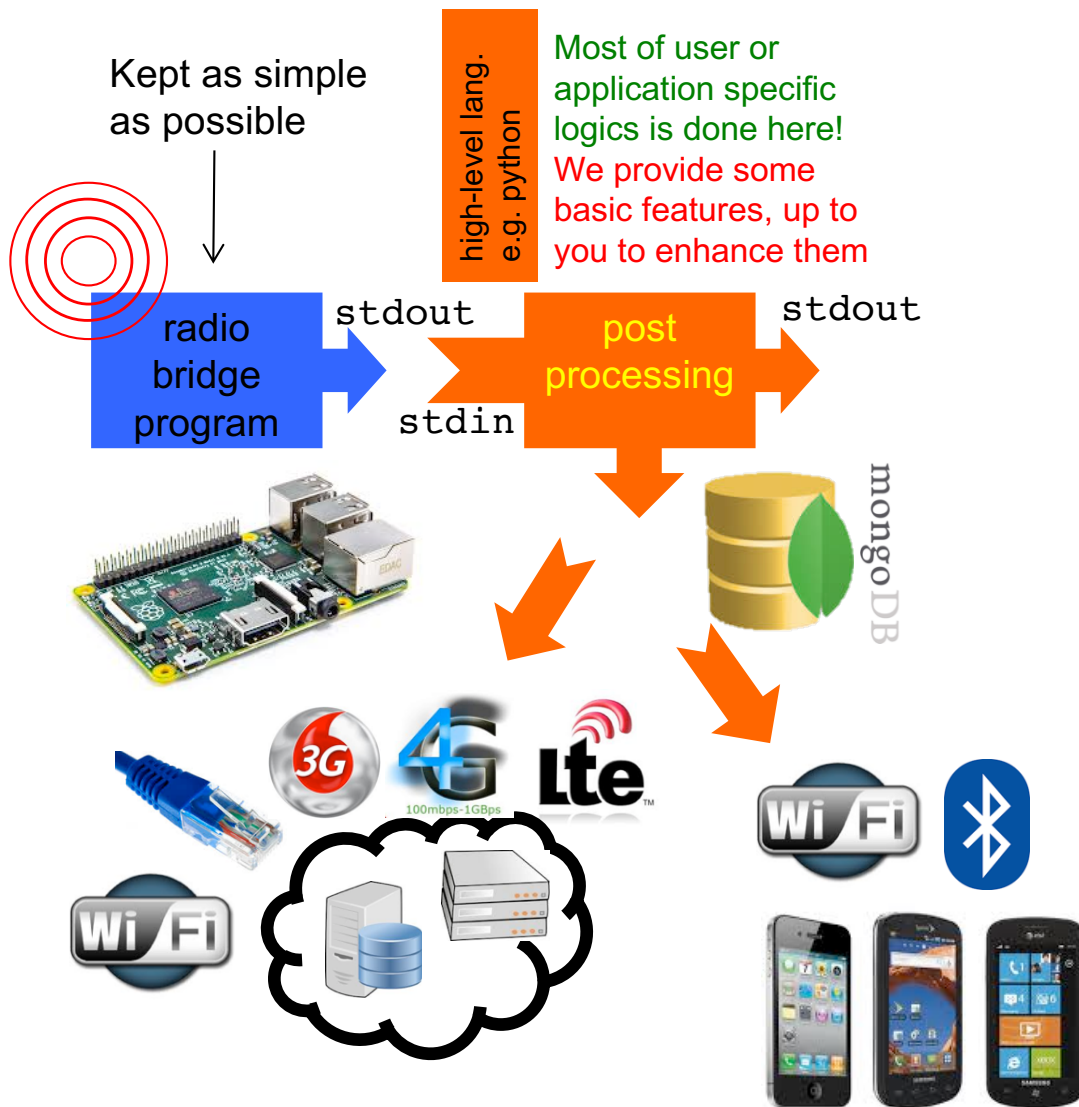
```
sendPacketTimeout("TC/18.5");  
// sends to gateway  
// TC : temperature celcius  
// 18.5 : value
```

1 send function!

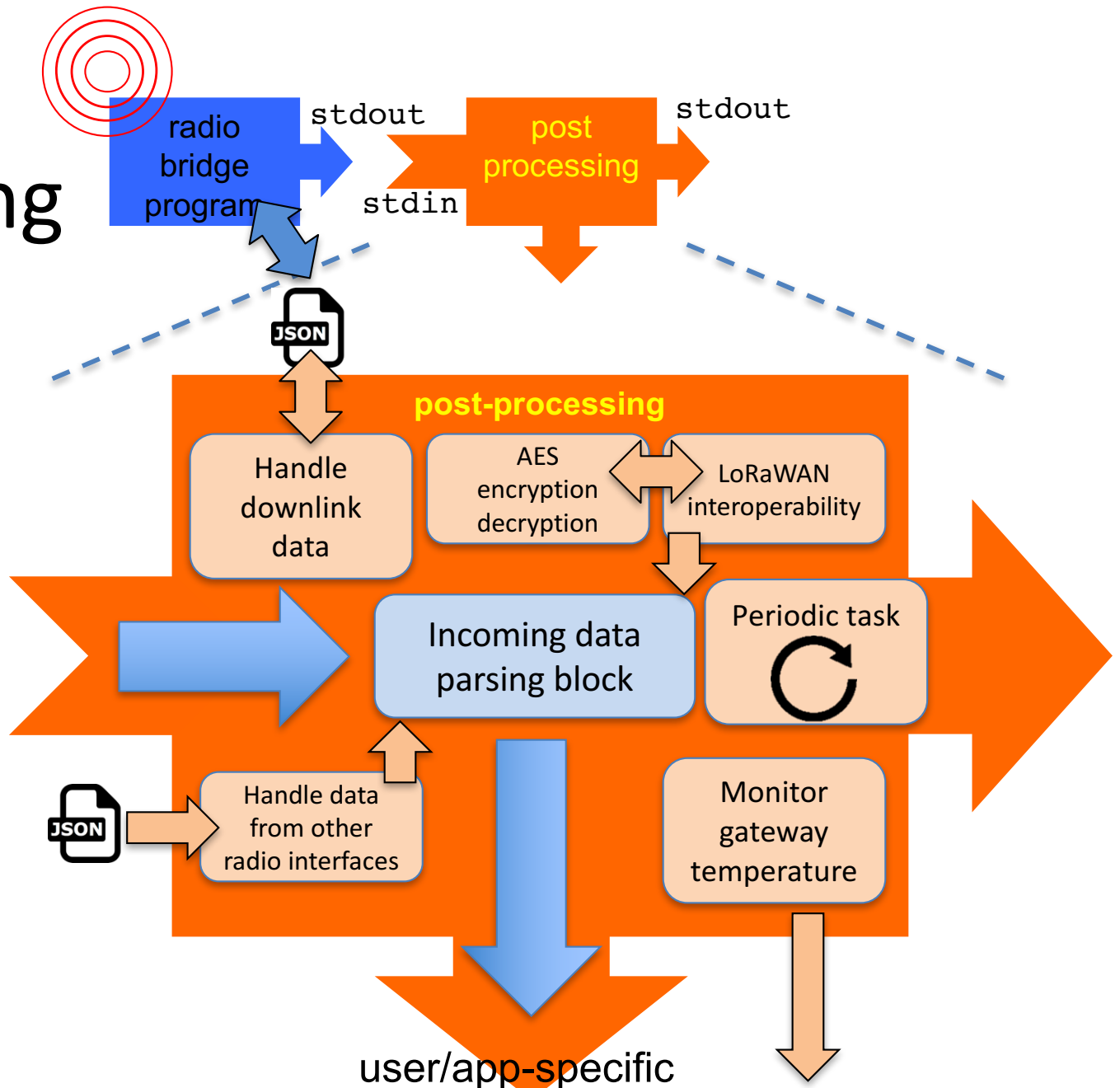




OUR LOW-COST GATEWAY ARCHITECTURE

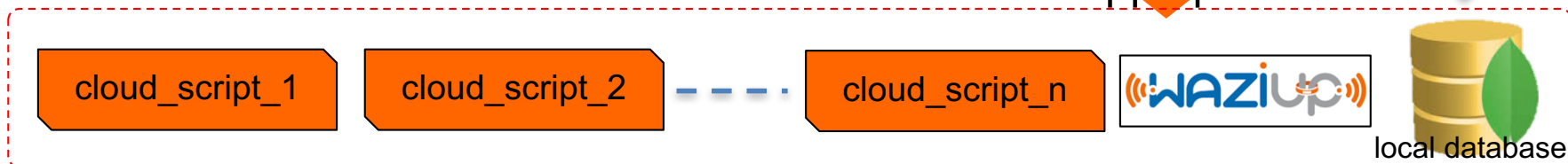


Post-processing stage



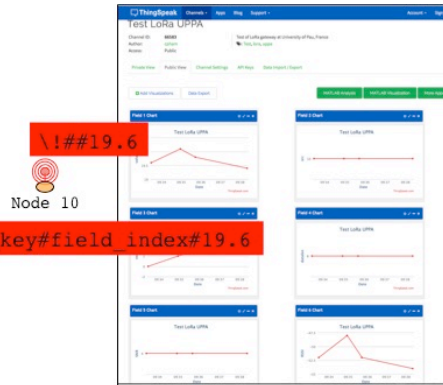
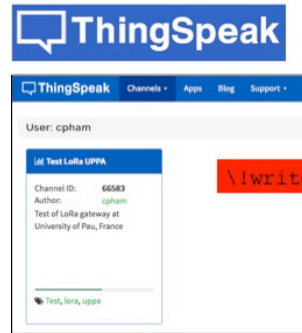
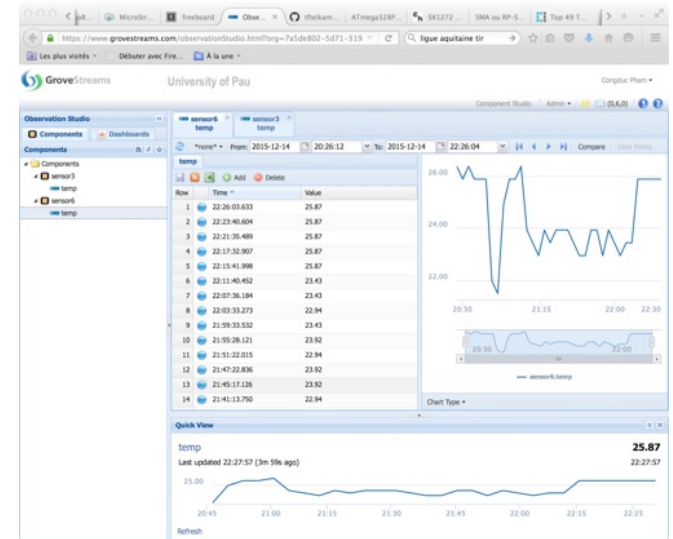
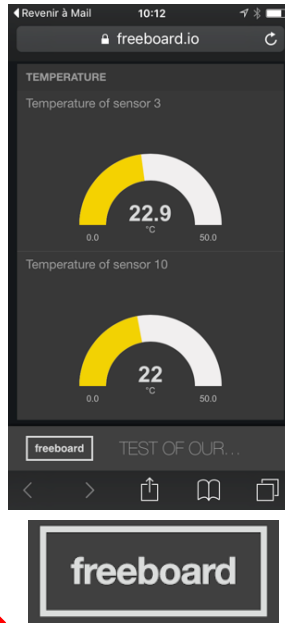
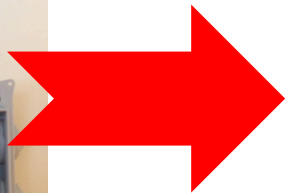
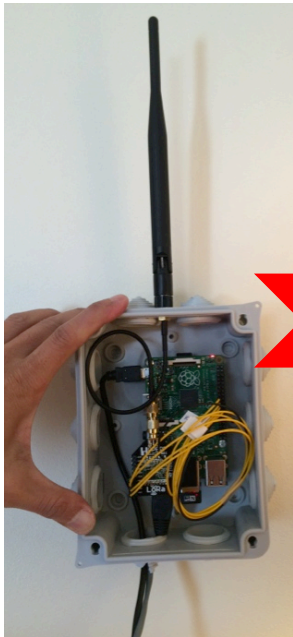
Cloud definition

user/app-specific





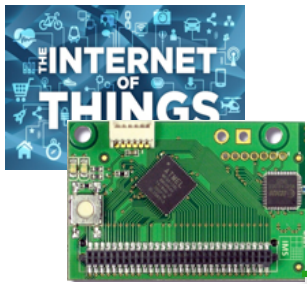
TEMPLATES FOR VARIOUS CLOUDS



```
\\!##19.6
Node 10
\\write_key#field_index#19.6
```

And much more: HTTP, FTP, MQTT, Node-Red...





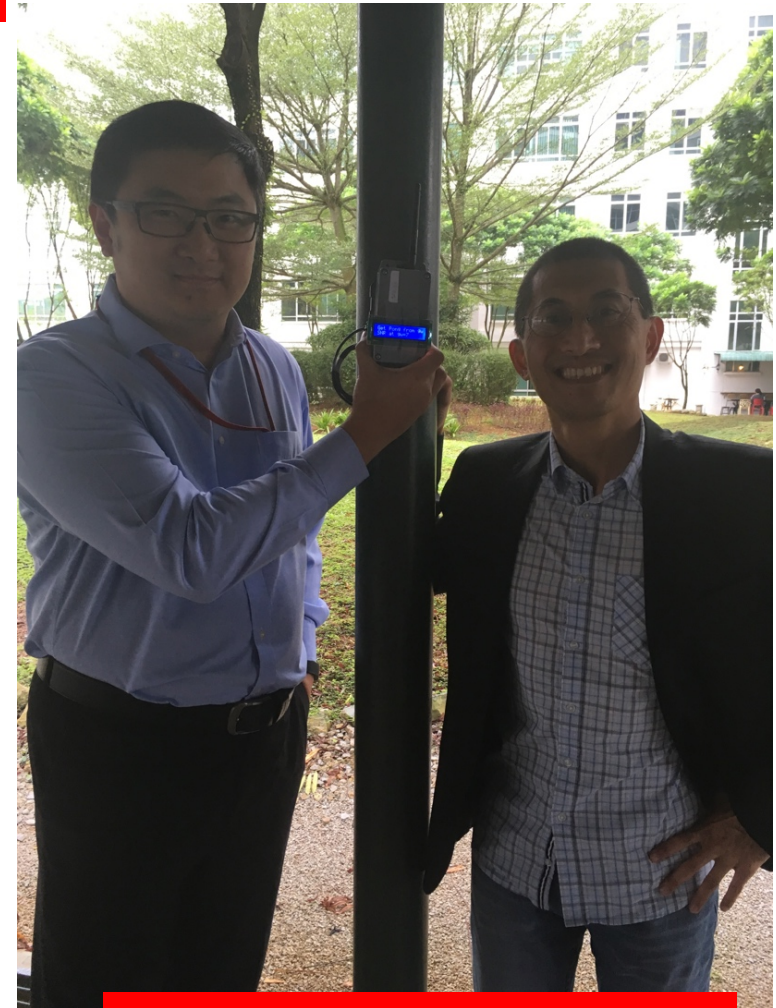
DEMO AT SUTS-CDF



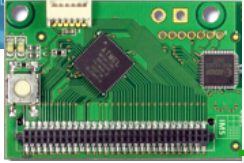
Temperature sensor



Gateway in CDF, at 9th floor



Range test at ground floor



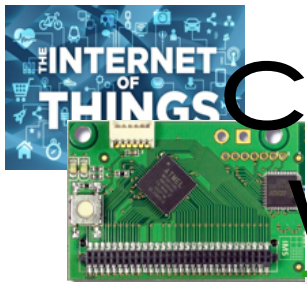
CLOUDS.JSON

```
{
  "clouds": [
    {
      "notice": "do not remove the MongoDB cloud declaration",
      "name": "Local gateway MongoDB",
      "script": "python CloudMongoDB.py",
      "type": "database",
      "max_months_to_store": 2,
      "enabled": true
    },
    {
      "name": "WAZIUP Orion cloud",
      "script": "python CloudOrion.py",
      "type": "iotcloud",
      "write_key": "",
      "enabled": true
    },
    {
      "name": "ThingSpeak cloud",
      "script": "python CloudThingSpeak.py",
      "type": "iotcloud",
      "write_key": "",
      "enabled": true
    },
    {
      "name": "GroveStreams cloud",
      "script": "python CloudGroveStreams.py",
      "type": "iotcloud",
      "write_key": "",
      "enabled": false
    },
    {
      "name": "Firebase cloud",
      "script": "python CloudFireBase.py",
      "type": "jsoncloud",
      "write_key": "",
      "enabled": false
    }
  ]
}
```

For each cloud, you have to provide a script and the launcher program (e.g. python)

Enabled clouds will be called by the post-processing stage

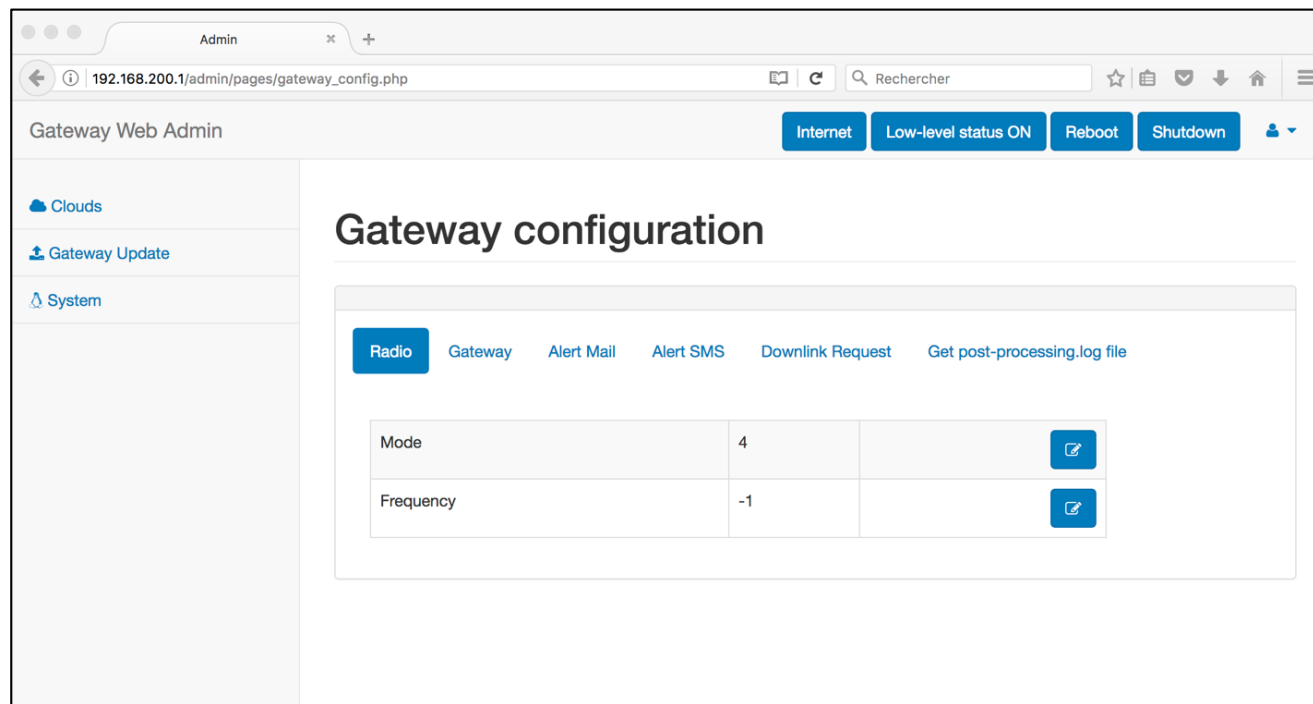
Each cloud script can incorporate parameters from a dedicated configuration file, e.g. key_ThingSpeak.py for CloudThingSpeak.py

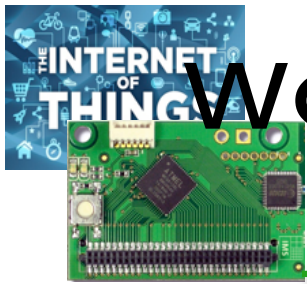


CONFIGURE YOUR GATEWAY WITH THE WEB INTERFACE

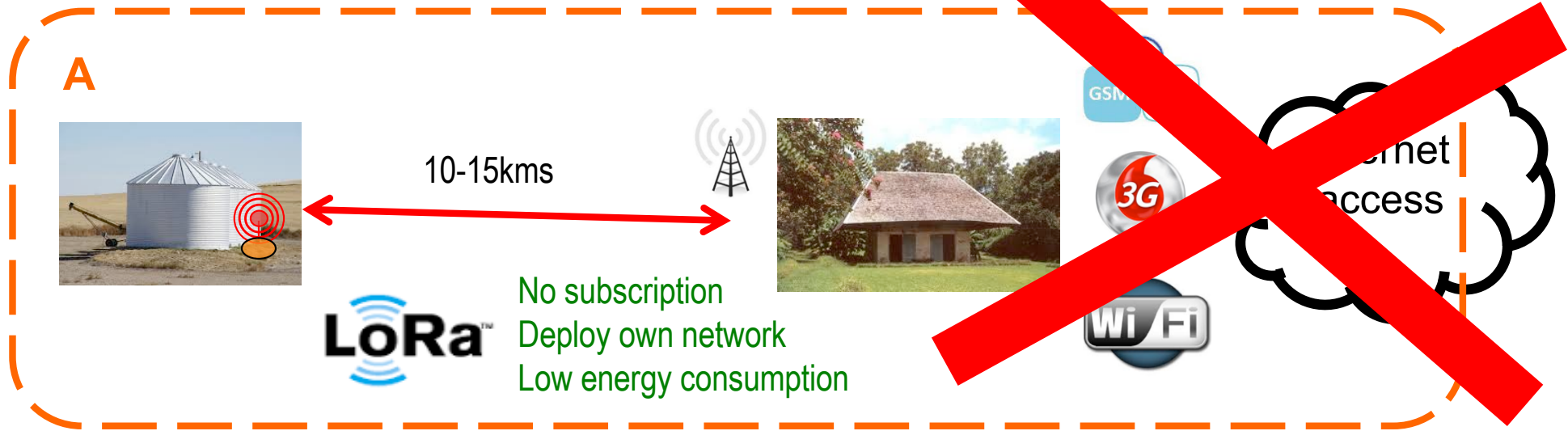


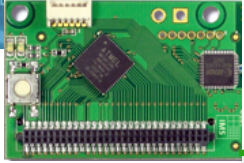
- <http://192.168.200.1/admin>
- Login: admin
- Password: loragateway



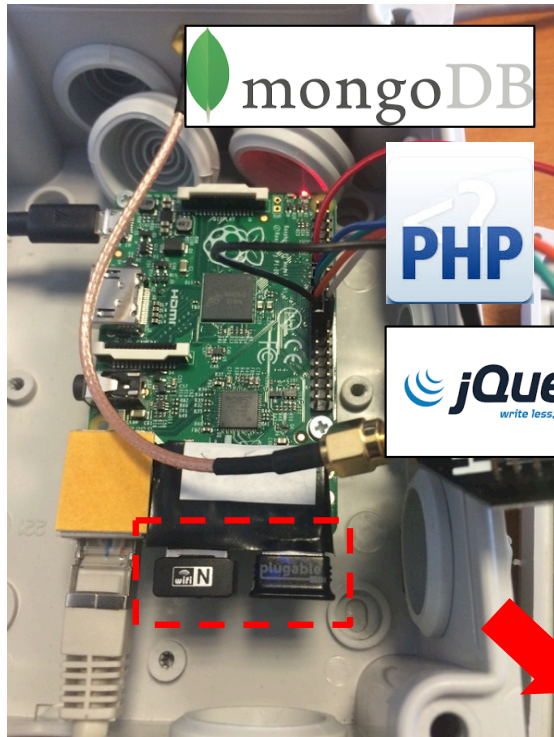


WORKING WITHOUT INTERNET ACCESS





STANDALONE GATEWAY



mongoDB



PHP

jQuery
write less, do more.

Access to the data from MongoDB

export data to csv

Display the 10 last document(s)

Sort by date

Valid

2016-12-15 15:47:58
2016-12-15 15:41:29
2016-12-15 15:36:24
2016-12-15 15:28:32
2016-12-15 15:24:50
2016-12-15 16:13:26
2016-12-15 15:03:38
2016-12-15 15:01:52
2016-12-15 14:56:37
2016-12-15 14:51:40

Display data: RSSI TC DEF

Display sources: node_3 node_6 node_10

Zoom to: Whole period Last month Current month Last seven days

Current day

Isolated areas



Orange F

Bluetooth_raspi

```

NODE: 1 DATE: 2016-05-09 08:04:59.807000 DATA: {"lw": 3.29, "th": 22.6, "hu": 50.7}
NODE: 1 DATE: 2016-05-09 08:28:52.993000 DATA: {"lw": 3.29, "th": 22.89, "hu": 50.29}
NODE: 1 DATE: 2016-05-09 08:53:04.317000 DATA: {"lw": 3.29, "th": 23.2, "hu": 50.79}
NODE: 1 DATE: 2016-05-09 09:05:00.997000 DATA: {"lw": 3.29, "th": 23.29, "hu": 51.29}
NODE: 1 DATE: 2016-05-09 09:17:24.482000 DATA: {"lw": 3.29, "th": 23.39, "hu": 51.7}
NODE: 1 DATE: 2016-05-09 09:41:27.437000 DATA: {"lw": 3.29, "th": 23.6, "hu": 52.0}
NODE: 1 DATE: 2016-05-09 10:05:39.032000 DATA: {"lw": 3.29, "th": 23.79, "hu": 51.5}
NODE: 1 DATE: 2016-05-09 10:17:45.186000 DATA: {"lw": 3.29, "th": 23.79, "hu": 50.79}
NODE: 1 DATE: 2016-05-09 10:29:24.285000 DATA: {"lw": 3.29, "th": 23.79, "hu": 50.79}
NODE: 1 DATE: 2016-05-09 10:53:09.347000 DATA: {"lw": 3.29, "th": 23.79, "hu": 51.9}
NODE: 1 DATE: 2016-05-09 11:17:02.953000 DATA: {"lw": 3.29, "th": 23.5, "hu": 50.79}
NODE: 1 DATE: 2016-05-09 11:52:53.334000 DATA: {"lw": 3.29, "th": 23.29, "hu": 50.7}
NODE: 1 DATE: 2016-05-09 12:04:32.437000 DATA: {"lw": 3.29, "th": 23.5, "hu": 50.29}
NODE: 1 DATE: 2016-05-09 12:16:56.116000 DATA: {"lw": 3.29, "th": 23.6, "hu": 50.29}
    
```

Display data Retrieve data in a csv file

Orange F

Bluetooth_raspi

NODES PREFERENCES

1 check to retrieve its data

8 check to retrieve its data

DATES PREFERENCES

Pick a begin date
Retrieve data since 09-05-2016

Pick an end date
Retrieve data until 17-05-2016

Display data Retrieve data in a csv file

Orange F

Bluetooth_raspi

Creating .csv file with the data received...
File 17-05-2016_10h39m36s.csv created and saved in the folder /storage/emulated/0/Raspberry_local_data

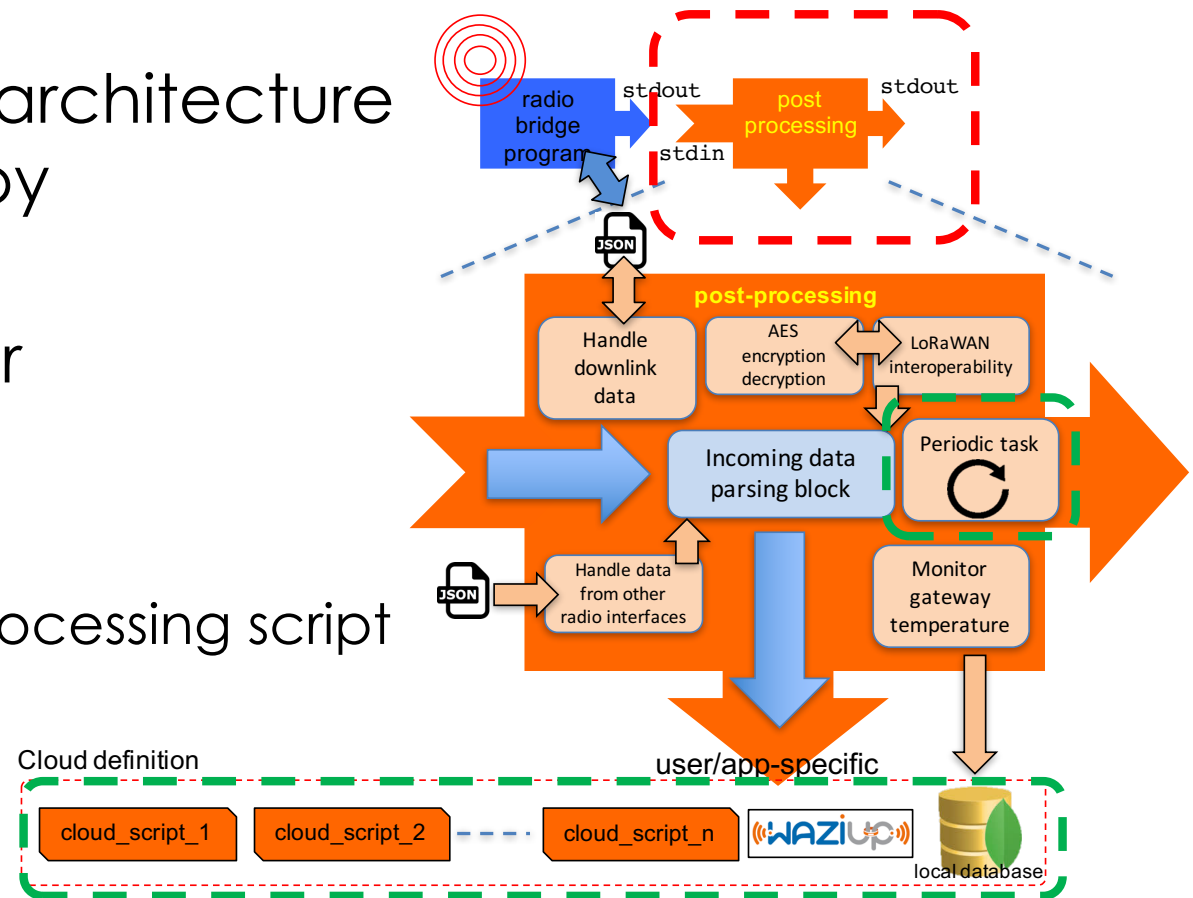
Display data Retrieve data in a csv file

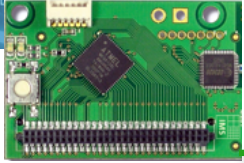


CUSTOMIZING/EXTENDING YOUR GATEWAY



- ❑ The flexible gateway architecture offers high versatility by customization
- ❑ There are 3 options for customization
- ❑ **The geek way**
 - ❑ Modify/extend post-processing script
- ❑ **The "smarter" way**
 - ❑ Add "cloud" scripts
 - On packet reception
 - ❑ Add periodic tasks
 - Independant from packet reception



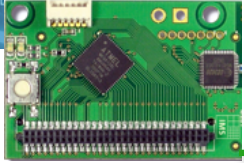


WRITE YOUR OWN CLOUD SCRIPT

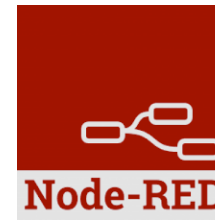


- ❑ Use our templates to write your own cloud script
- ❑ A cloud script is called with 5 arguments
 - ldata: the received data
 - e.g. #4#TC/21.5 as 1st argument (sys.argv[1] in python)
 - pdata: packet information
 - e.g. “1,16,3,0,10,8,-45” as 2nd argument (sys.argv[2] in python)
 - interpreted as dst,ptype,src,seq,len,SNR,RSSI for the last received packet
 - rdata: the LoRa radio information
 - e.g. “500,5,12” as 3rd argument (sys.argv[3] in python)
 - interpreted as bw,cr,sf for the last received packet
 - tdata: the timestamp information
 - e.g. “2016-10-04T02:03:28.783385” as 4th argument (sys.argv[4] in python)
 - gwid: the gateway id
 - e.g. 00000027EBBEDA21 as 5th argument (sys.argv[5] in python)

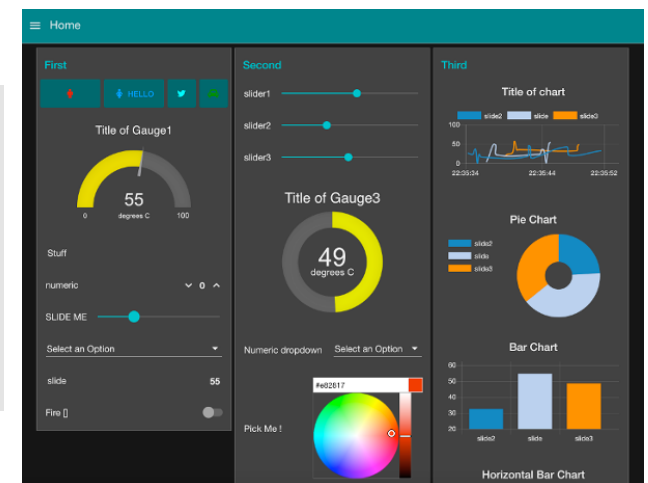
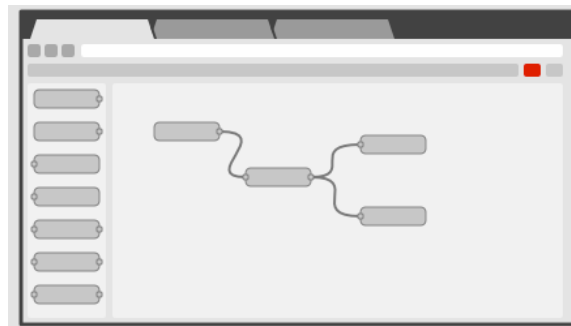
These parameters are passed to the script. It is up to the cloud script to use these parameters or not.



EX: NODE-RED

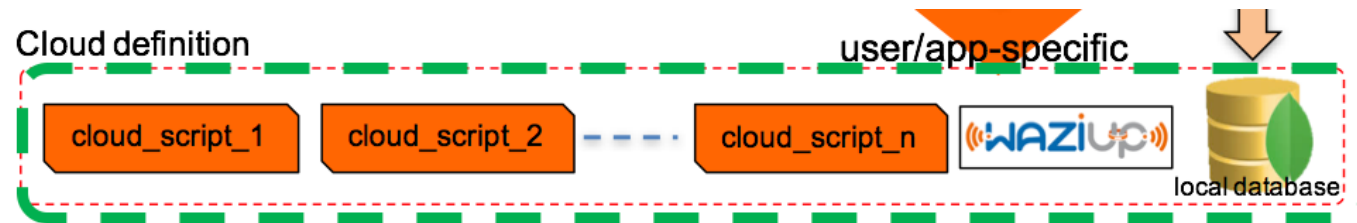


- ❑ Node-RED is a programming tool for wiring together hardware devices, APIs and online services, e.g. clouds of various types
- ❑ provides a browser-based flow editor to wire together flows with a wide range of nodes

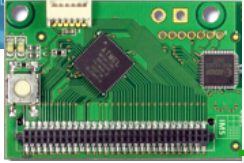




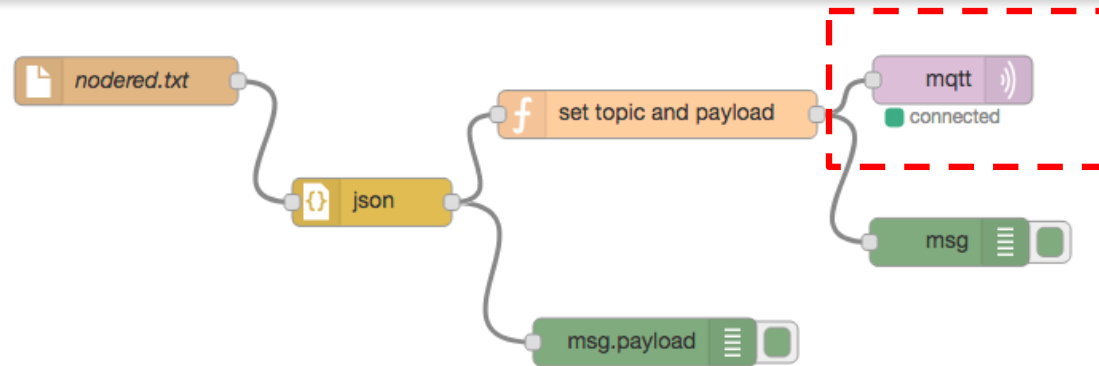
CLOUDNODERED.PY



- ❑ CloudNodeRed.py shows how interface with Node-Red can be simply implemented to benefit from the facility offered by Node-Red
- ❑ 3 variables will be used by CloudNodeRed.py
 - ❑ `project_name="waziup"`
 - ❑ `organization_name="UPPA"`
 - ❑ `sensor_name="Sensor"`
- ❑ when a device which address is 2 sends "TC/21.65/HU/85" to the gateway, CloudNodeRed.py will generate the following json entries in `nodered/nodered.txt` file
 - ❑ `{"source":"waziup_UPPA_Sensor2","measure":"TC","value":21.65}`
 - ❑ `{"source":"waziup_UPPA_Sensor2","measure":"HU","value":85}`



ADDING MQTT



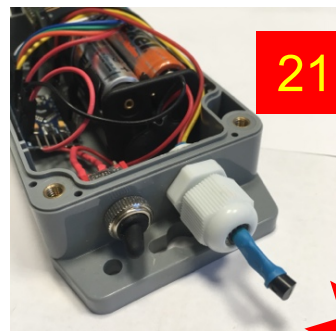
- ❑ An MQTT node using the `test.mosquitto.org` broker will receive the messages with the topic defined as `waziup_UPPA_Sensor2/TC` and `waziup_UPPA_Sensor2/HU`
- ❑ It will then respectively publish 21.65 and 85 under these topics
- ❑ More information on:
 - ❑ https://github.com/CongducPham/LowCostLoRaGw/blob/master/gw_full_latest/README-NodeRed.md



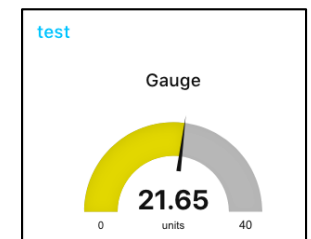
THE NODE-RED ENABLED GATEWAY

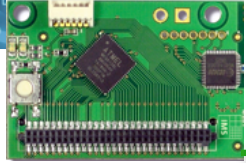


- Messages received on the gateway can be injected into a Node-Red flow, allowing complex data processing to be defined



21.65



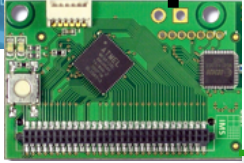


ANOTHER EXAMPLE WITH CLOUDGPSFILE.PY

- ❑ CloudGpsFile.py is a dedicated "cloud" module that will search in incoming messages a valid 'LAT' and 'LGT' field such as in "BC/9/LAT/43.31402/LGT/-0.36370/FXT/4180"
- ❑ You can enable CloudGpsFile.py in clouds.json. When a message with valid GPS coordinates is received, CloudGpsFile.py will write an entry in gps/gps.txt file containing relevant packet and GPS information, including the distance (in km) between the gateway and the GPS device

```
src waziup_UPPA_Sensor15 seq 188 bc 9 snr 5 rssi -90 time 2017-11-20T14:18:54 gw
00000027EB5171F7 fxt 4180 lat 43.31402 lgt -0.36370 distance 0.0224
```

- ❑ For distance calculation, the gateway position **MUST** be provided in the gateway_conf.json file (see Annex)
- ❑ **For range test campaign**, you can import (or copy/paste) this file in an Excel sheet to plot distance against SNR/RSSI

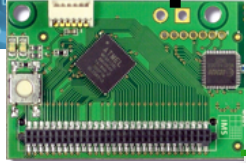


MAINTAINING A LIST OF GPS DEVICES (1)

- ❑ `CloudGpsFile.py` also maintains a list of GPS devices in `gps/gps.json`

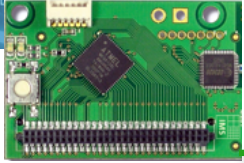
```
{
  "devices": [
    {
      "gw": "00000027EB5171F7",
      "src": "waziup_UPPA_Sensor15",
      "seq": 188,
      "distance": 0.0224,
      "fxt": 4180,
      "bc": 9,
      "lat": 43.31402,
      "snr": 8,
      "time": "2017-11-20T14:18:54",
      "active": "yes",
      "rssi": -45,
      "lgt": -0.3637
    }
  ]
}
```

- ❑ New devices (from `src` field) will be added, while existing devices will be updated

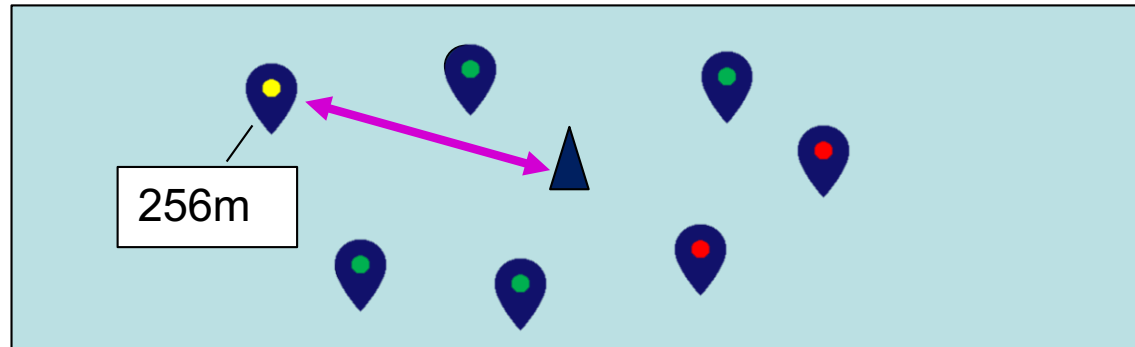





MAINTAINING A LIST OF GPS DEVICES (2)

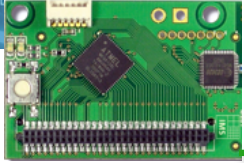
- ❑ `CloudGpsFile.py` also extract from the list of GPS devices those that have sent GPS information in during the last time window
- ❑ `key_GpsFile.py` defines
 - ❑ `active_interval_minutes=20`
 - ❑ For instance, devices that have sent GPS info in the last 20 minutes will be indicated as active
- ❑ Those active devices are further maintained in `gps/active_gps.json`
- ❑ Further versions can also create kml or gpx file or any combination that would allow more complex visualization features



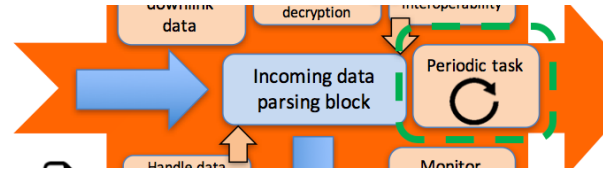
A WEB INTERFACE FOR TRACKING GPS DEVICES



- ❑ A web interface could use `gps/gps.json` and `gps/active_gps.json` to show:
 - ❑ the last updated GPS device 
 - ❑ active devices  (in the last time window)
 - ❑ inactive devices  that have not been updated in the last time window
- ❑ This feature is especially usefull in mobility scenario



EXTENDING BY ADDING A NEW PERIODIC TASK



- ❑ Illustration with dynamic gateway GPS position
- ❑ The gateway's coordinates are stored in `gateway_conf.json`

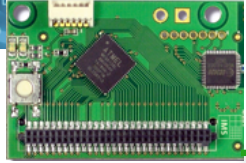
```

"gateway_conf" : {
    "gateway_ID" : "000000XXXXXXXXXX",
    "ref_latitude" : "43.31416",
    "ref_longitude" : "-0.36430",

```

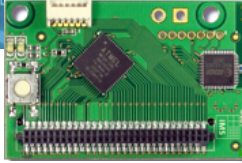
- ❑ In a mobility scenario, the position of the gateway can be updated
- ❑ `post_status_processing_gw.py` which is periodically called by the main post-processing loop can be extended to get the position of the gateway using a connected GPS module.





WHEN ENABLING DYNAMIC_GPS

- ❑ Enabling `dynamic_gps` in `gateway_conf.json` activates the following tasks
 - ❑ `post_status_processing_gw.py` which is periodically called by `post_processing_gw.py` will try to get the position of the gateway using a connected GPS module. It uses `get_gps.py` in the `sensors_in_raspi` folder
 - ❑ `get_gps.py` produces a `gateway_gps.txt` file if a valid GPS fix is obtained. The file simply contains the coordinates in decimal degree: `43.31427, -0.36424`
 - ❑ If `post_status_processing_gw.py` finds a `gateway_gps.txt` file, it will update in `gateway_conf.json` the GPS coordinate fields used by `CloudGpsFile.py`



TUTORIALS/RESOURCES



<https://github.com/CongducPham/tutorials>

WAZIUP
 101 823200 grant agreement number 887167

Low-cost LoRa IoT devices and gateway FAQ

1) **What is Internet-of-Thing (IoT)?**
 From IERC (European Research Cluster on the Internet of Things)
 The IERC definition states that IoT is "a dynamic global network infrastructure with self-configuring capabilities based on standard and interoperable communication protocols where physical and virtual "things" have identities, physical attributes, and virtual personalities and use intelligent interfaces, and are seamlessly integrated into the information network."
 From <http://www.gartner.com/it-glossary/internet-of-things/>
 "The Internet of Things (IoT) is the network of physical objects that contain embedded technology to communicate and sense or interact with their internal states or the external environment."
 From <http://internetofthingsagenda.techtarget.com/definition/Internet-of-Things-IoT>
 "The Internet of Things (IoT) is a system of interrelated computing devices, mechanical and digital machines, objects, animals or people that are provided with unique identifiers and the ability to transfer data over a network without requiring human-to-human or human-to-computer interaction."

2) **What is WAZIUP?**
 The EU H2020 WAZIUP project, namely the Open Innovation Platform for IoT-Big Data in Sub-Saharan Africa is a collaborative research project using cutting edge technology applying IoT and Big Data to improve the working conditions in the rural ecosystem of Sub-Saharan Africa. First, WAZIUP operates by involving farmers and breeders in order to define the platform specifications in focused validation cases. Second, while tackling challenges which are specific to the rural ecosystem, it also engages the flourishing ICT ecosystem in those countries by fostering new tools and good practices, entrepreneurship and start-ups. Aimed at boosting the ICT sector, WAZIUP proposes solutions aiming at long term sustainability.
 WAZIUP will deliver a communication and big data application platform and generate locally the know-how by training by use cases and examples. The use of standards will help to create an interoperable platform, fully open source, oriented to radically new paradigms for innovative applications/services delivery. WAZIUP is driven by the following visions:
 1. Empower the African rural
 empower the African rural of rapid urbanization and support the necessary breeding on a new scale

Author : Congduc Pham, University of Pau
 Last update : 07.09.2016

TUTORIAL ON HARDWARE & SOFTWARE FOR LOW-COST LONG-RANGE IOT

WAZIUP

LIUPPA T21 team

PROF. CONGDUC PHAM
[HTTP://WWW.UNIV-PAU.FR/~CPHAM](http://www.univ-pau.fr/~cpham)
 UNIVERSITE DE PAU, FRANCE

UNIVERSITE DE PAU ET DES PAYS DE L'ADOUR

LOW-COST LORA IOT DEVICE: A STEP-BY-STEP TUTORIAL

WAZIUP

LIUPPA T21 team

PROF. CONGDUC PHAM
[HTTP://WWW.UNIV-PAU.FR/~CPHAM](http://www.univ-pau.fr/~cpham)
 UNIVERSITE DE PAU, FRANCE

UNIVERSITE DE PAU ET DES PAYS DE L'ADOUR

BUILDING AN IOT DEVICE FOR OUTDOOR USAGE: A STEP-BY-STEP TUTORIAL

WAZIUP

LIUPPA T21 team

PROF. CONGDUC PHAM
[HTTP://WWW.UNIV-PAU.FR/~CPHAM](http://www.univ-pau.fr/~cpham)
 UNIVERSITE DE PAU, FRANCE

UNIVERSITE DE PAU ET DES PAYS DE L'ADOUR

LOW-COST LORA IOT DEVICE: SUPPORTED PHYSICAL SENSORS

WAZIUP

LIUPPA T21 team

PROF. CONGDUC PHAM
[HTTP://WWW.UNIV-PAU.FR/~CPHAM](http://www.univ-pau.fr/~cpham)
 UNIVERSITE DE PAU, FRANCE

UNIVERSITE DE PAU ET DES PAYS DE L'ADOUR

LOW-COST LORA GATEWAY: A STEP-BY-STEP TUTORIAL

WAZIUP

LIUPPA T21 team

PROF. CONGDUC PHAM
[HTTP://WWW.UNIV-PAU.FR/~CPHAM](http://www.univ-pau.fr/~cpham)
 UNIVERSITE DE PAU, FRANCE

UNIVERSITE DE PAU ET DES PAYS DE L'ADOUR

LOW-COST LORA IOT: USING THE WAZIUP DEMO KIT

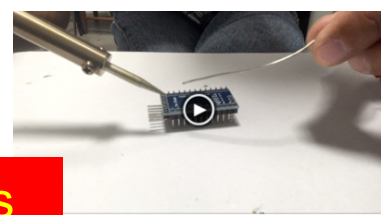
WAZIUP

LIUPPA T21 team

PROF. CONGDUC PHAM
[HTTP://WWW.UNIV-PAU.FR/~CPHAM](http://www.univ-pau.fr/~cpham)
 UNIVERSITE DE PAU, FRANCE

UNIVERSITE DE PAU ET DES PAYS DE L'ADOUR

Low-cost IoT device



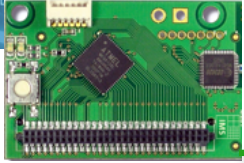
+53000 views

https://www.youtube.com/watch?v=YsKbJeeav_M

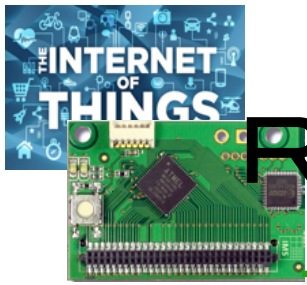
Low-cost IoT gateway



<https://www.youtube.com/watch?v=mj8ltKA14PY>



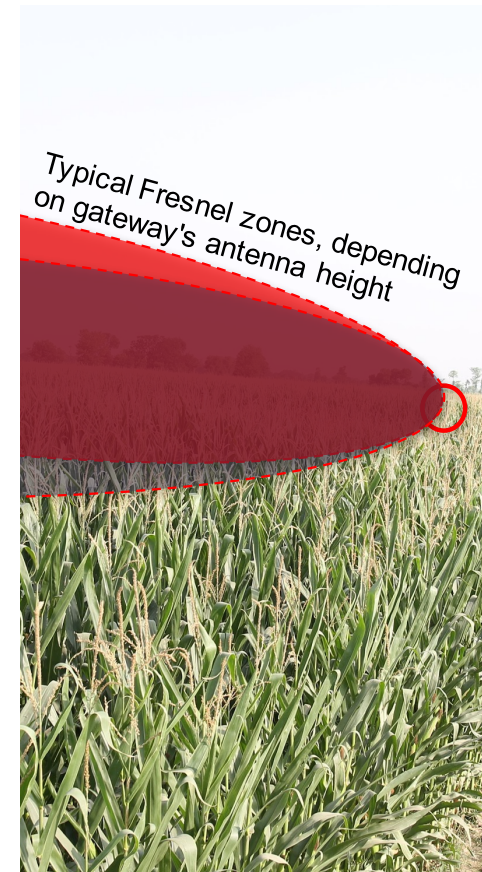
CONDUCTING RESEARCH WITH THE WAZIUP IOT PLATFORM

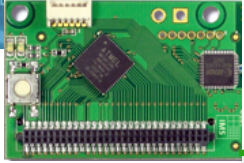


REAL-WORLD DEPLOYMENT



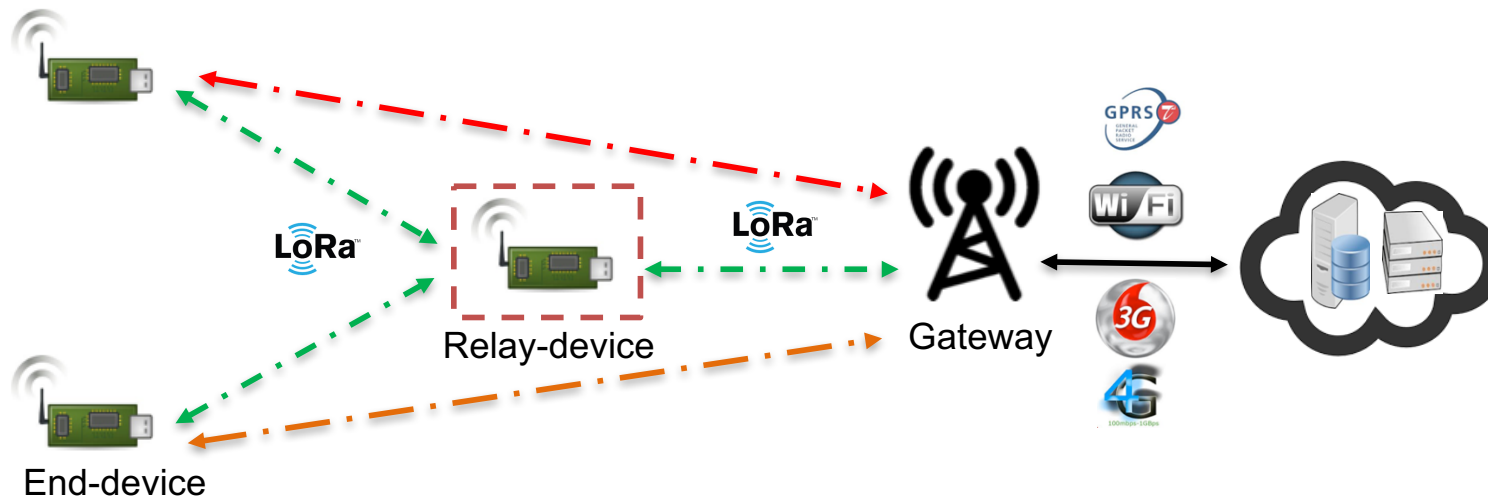
- Provides 2-hop LoRa to solve some connectivity issues in real-world deployment scenario

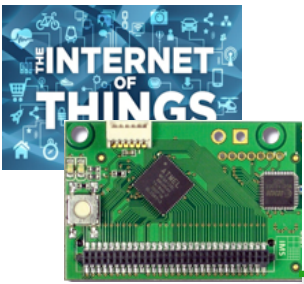




2-HOP LORA APPROACH

- Objective is to have a **smart, transparent** relay node that can be inserted at anytime between end-devices and gateway

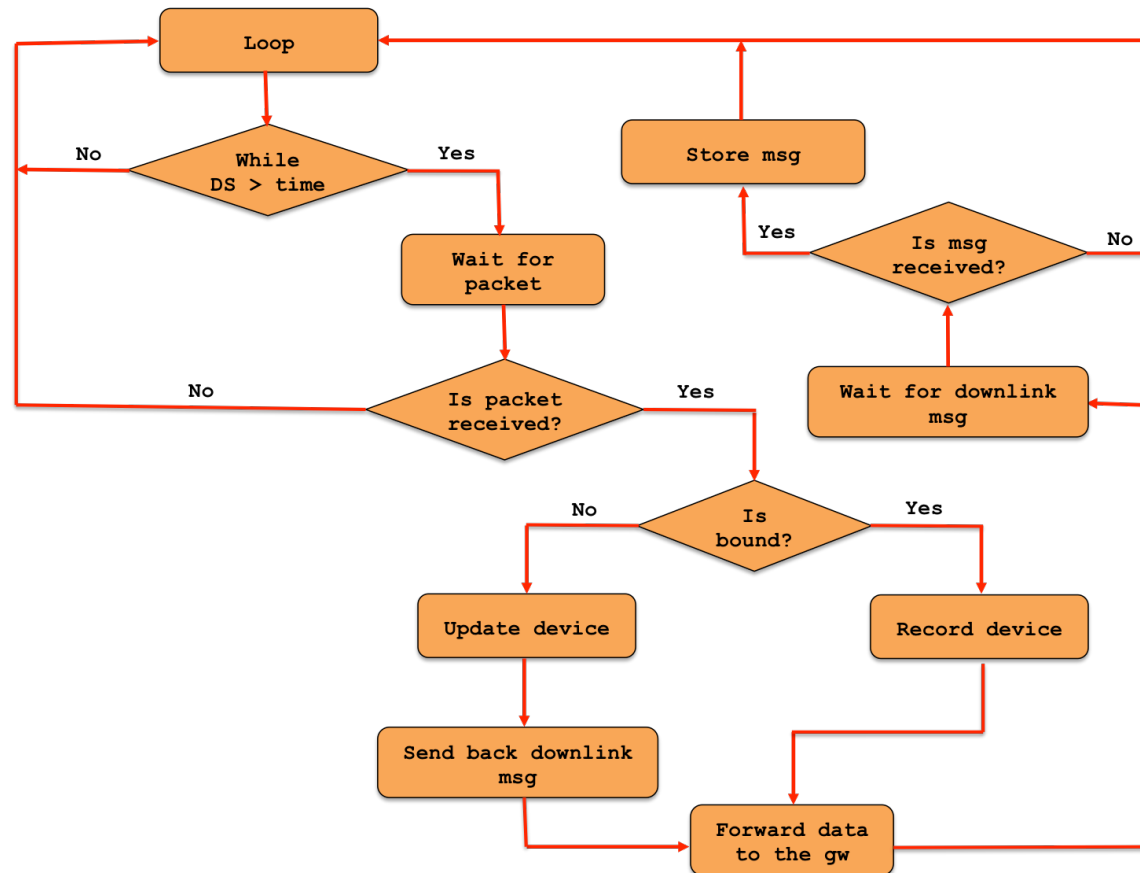


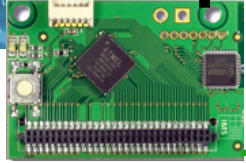


SMART RELAY DEVICE LEARNING ON-THE-FLY



- On-the-fly learning of incoming traffic from end-devices: **the observation phase**





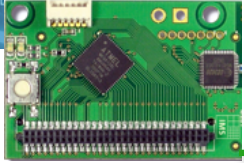
ROBUST CHANNEL ACCESS MECHANISMS



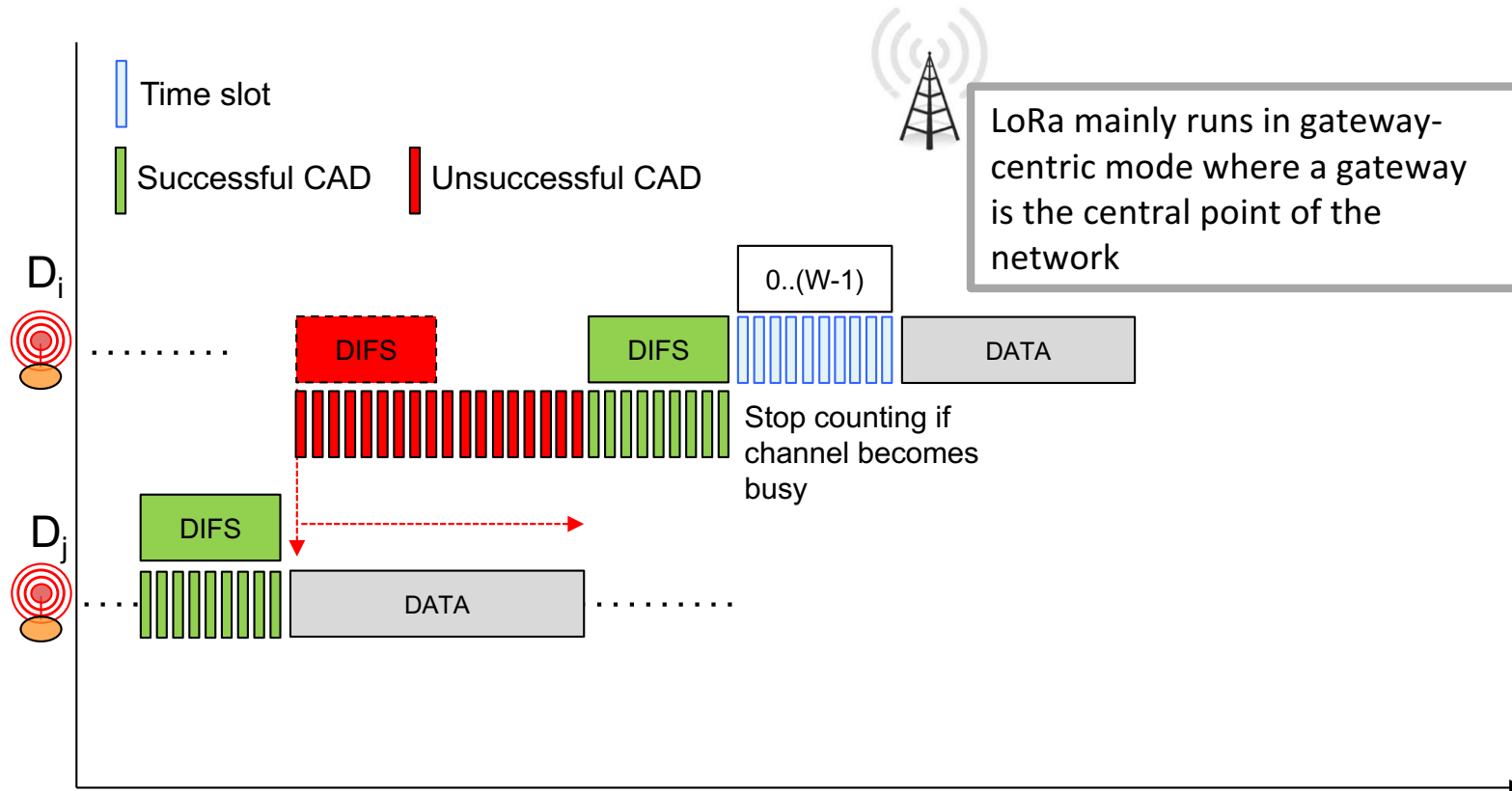
- With densier LoRa networks and more heterogeneous traffic (traditional+image sensors) it is necessary to provide a more robust channel access mechanism
- Objectives are to reduce packet collisions, thus reducing delivery latency, and reduce power consumption due to unsuccessful transmissions

C. Pham, "Investigating and Experimenting CSMA Channel Access Mechanisms for LoRa IoT Networks", IEEE WCNC'2018.

C. Pham, "Robust CSMA for Long-Range LoRa Transmissions with Image Sensing Devices", IEEE WD'2018.

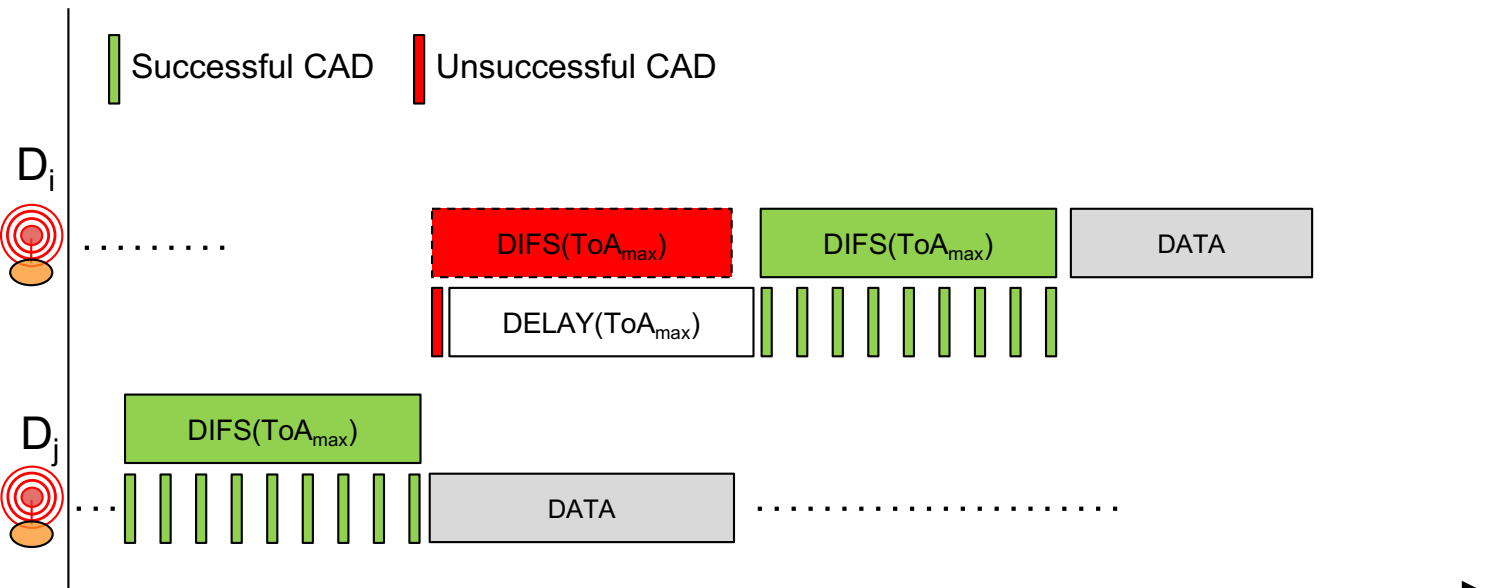
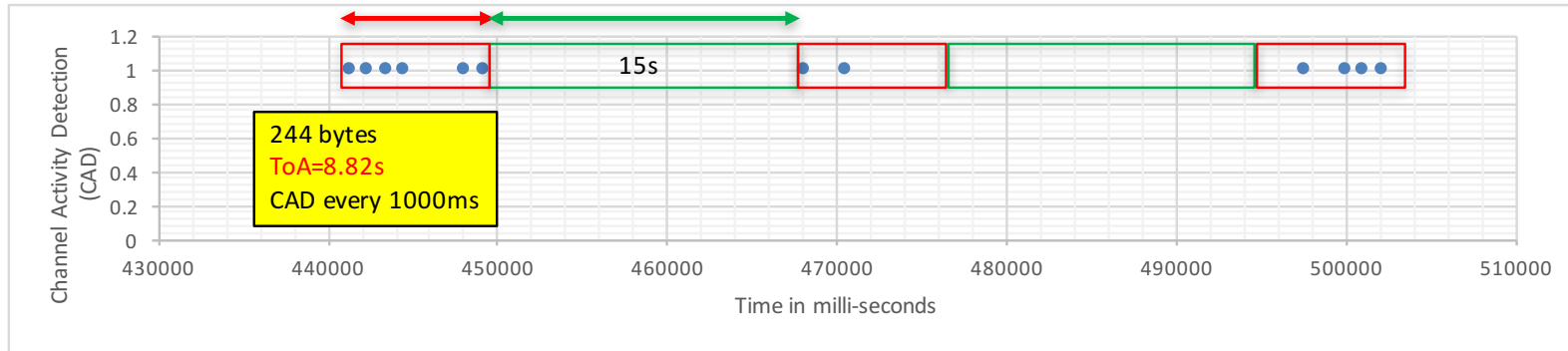


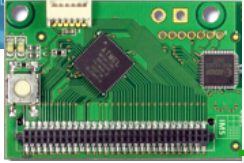
CSMA-BASED DERIVED FROM 802.11



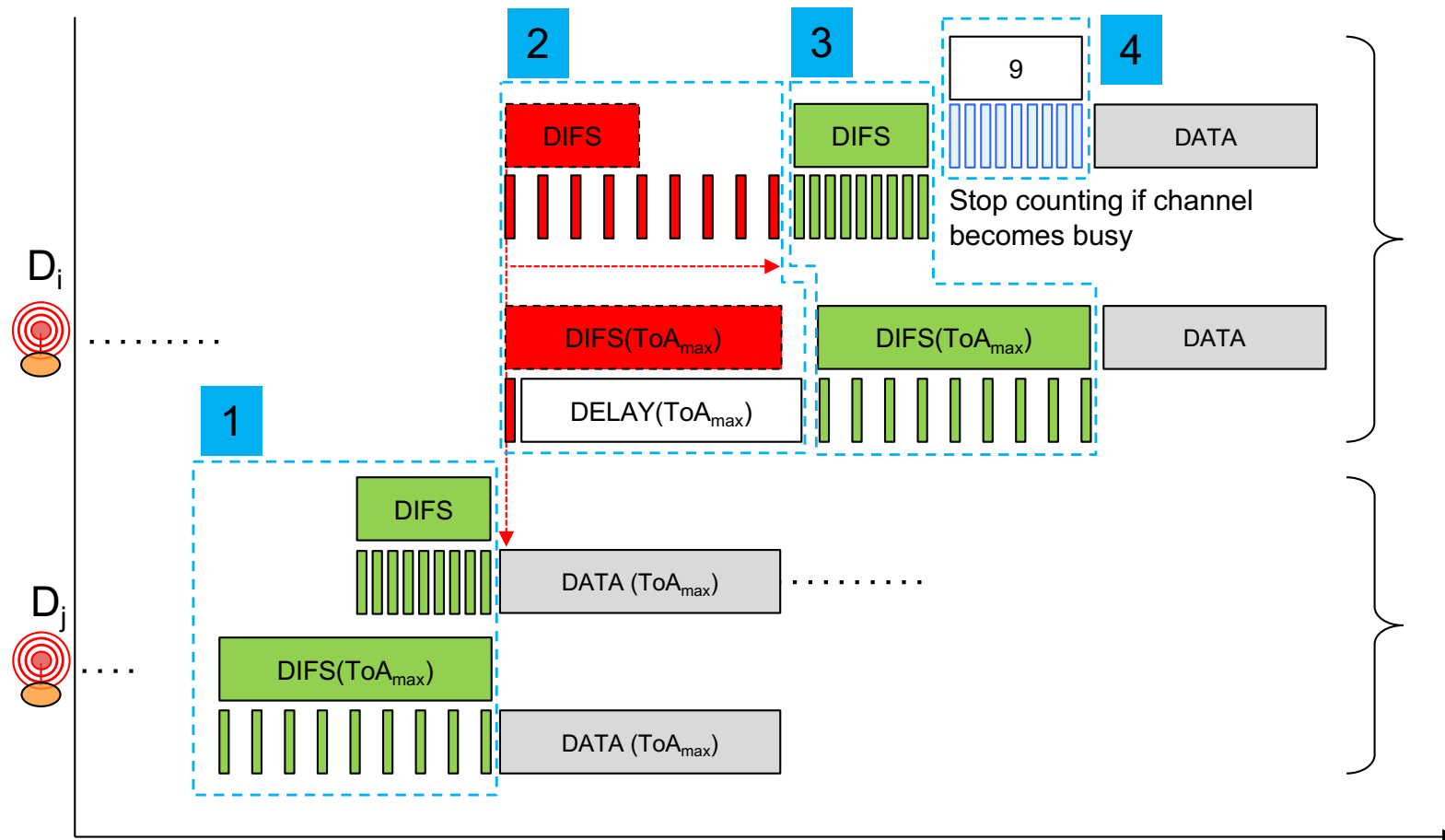


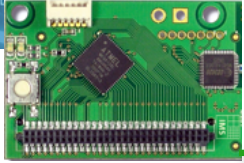
CSMA-BASED ADAPTED TO LONGER MSG





CSMA ALTERNATIVES & COMPARISON





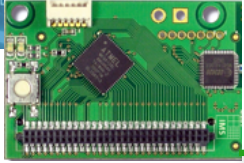
QUALITY OF SERVICE

- ❑ Regulations stipulate that **radio activity duty-cycle should be enforced at devices.**
- ❑ LoRaWAN specification from LoRa Alliance is a first attempt to standardize LoRa networks but **no issues on quality of service.**
- ❑ Proposition of a Long-range Activity Sharing (LAS) mechanism when running under duty-cycle regulations
- ❑ Allow a device to be able to send critical data without having to wait for the next cycle

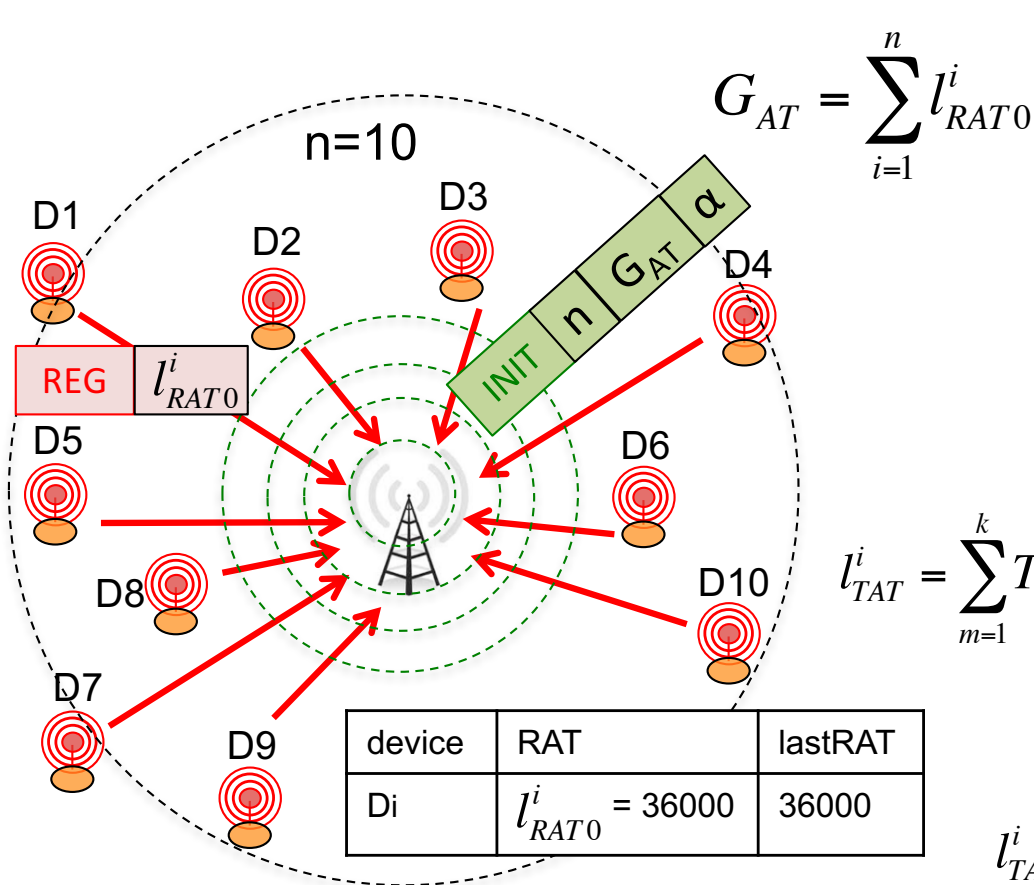
C. Pham, "Deploying a Pool of Long-Range Wireless Image Sensor with Shared Activity Time". Proceedings of the 11th IEEE WiMob'2015, October 19-21, 2015, Abu Dhabi, UAE.

C. Pham, "Towards Quality of Service for Long-range IoT in Unlicensed Radio Spectrum". IEEE Wireless Days (WD'2016), Toulouse, France, March 2016.

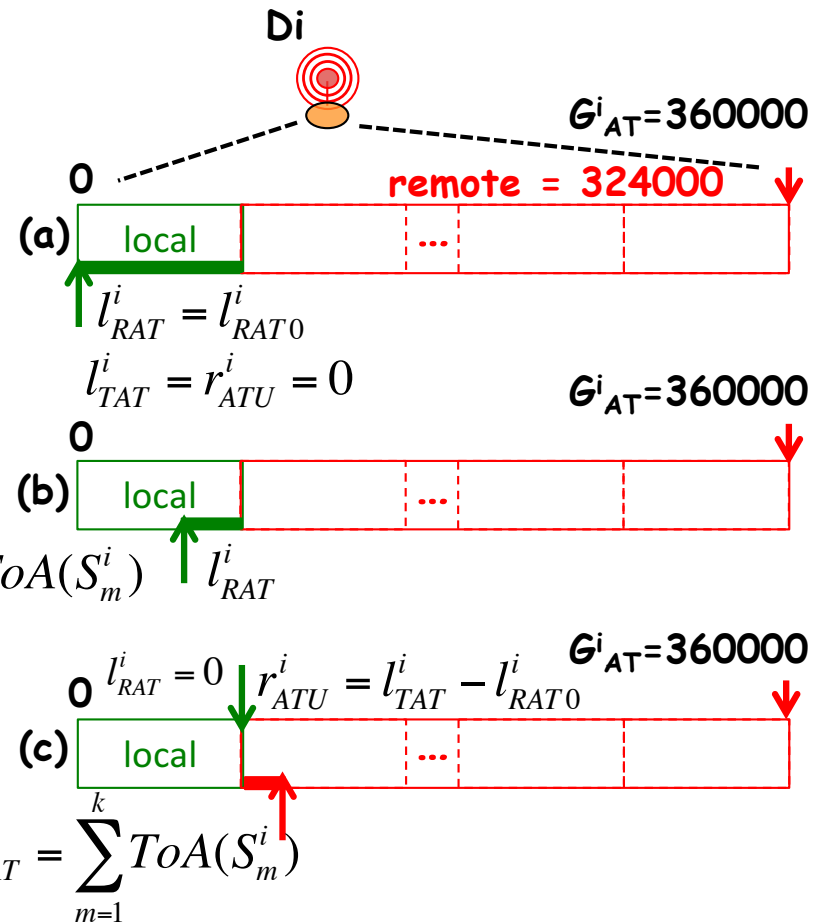
C. Pham, "QoS for Long-Range Wireless Sensors under Duty-Cycle Regulations with Shared Activity Time Usage". ACM Transactions on Sensor Networks, Vol. 12(4), 2016.



LONG-RANGE ACTIVITY SHARING (LAS)



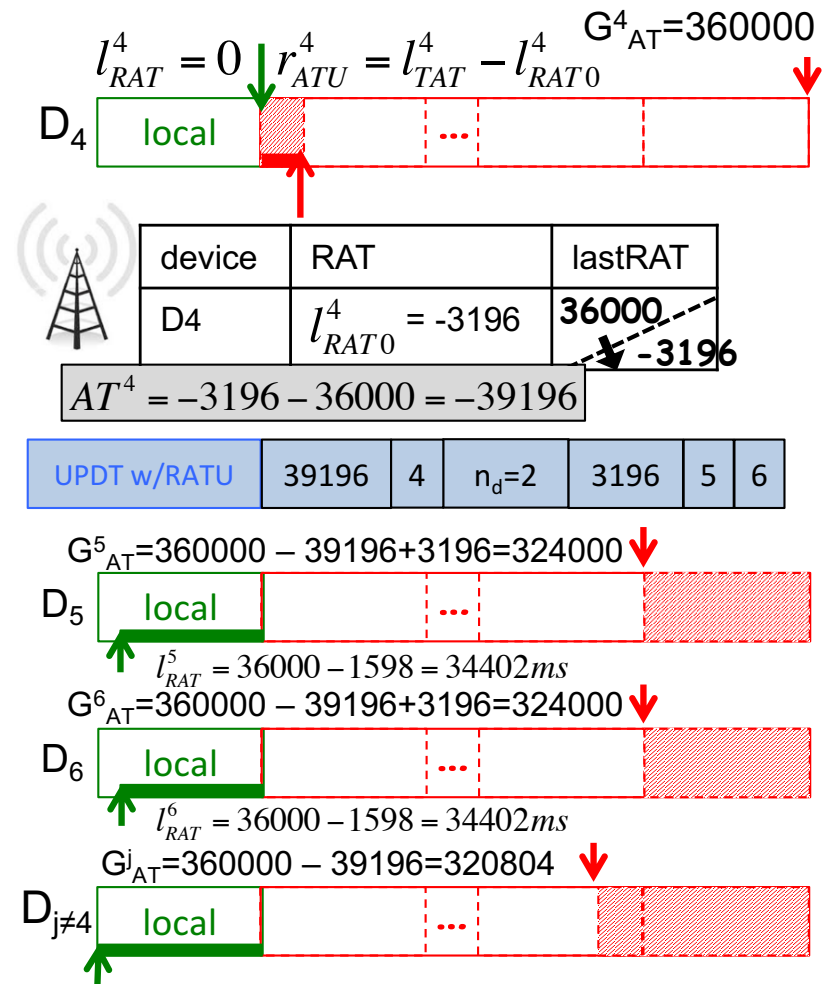
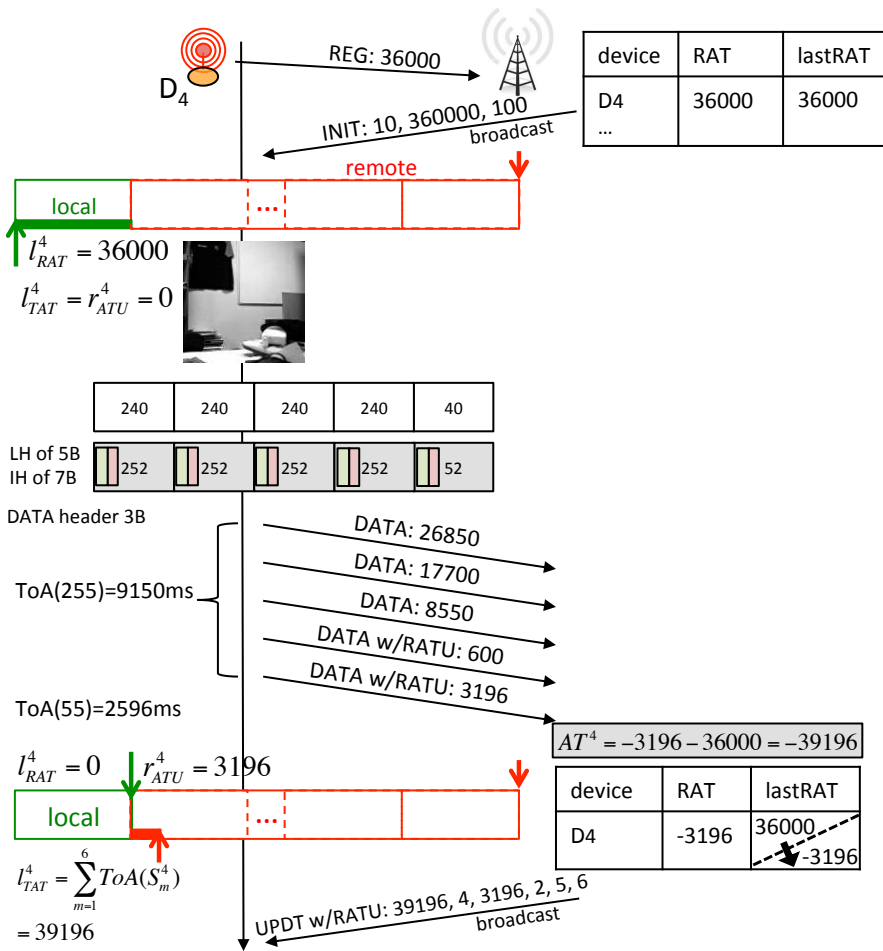
$$l^i_{TAT} = \sum_{m=1}^k ToA(S_m^i) \uparrow l^i_{RAT}$$

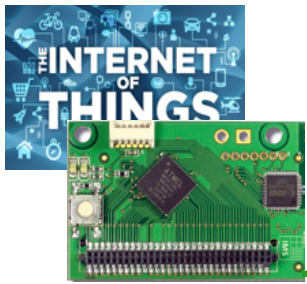


A device can transmit more if needed, provided that other devices will decrease their radio activity time accordingly.



DISTRIBUTING REMOTE ACTIVITY TIME USAGE

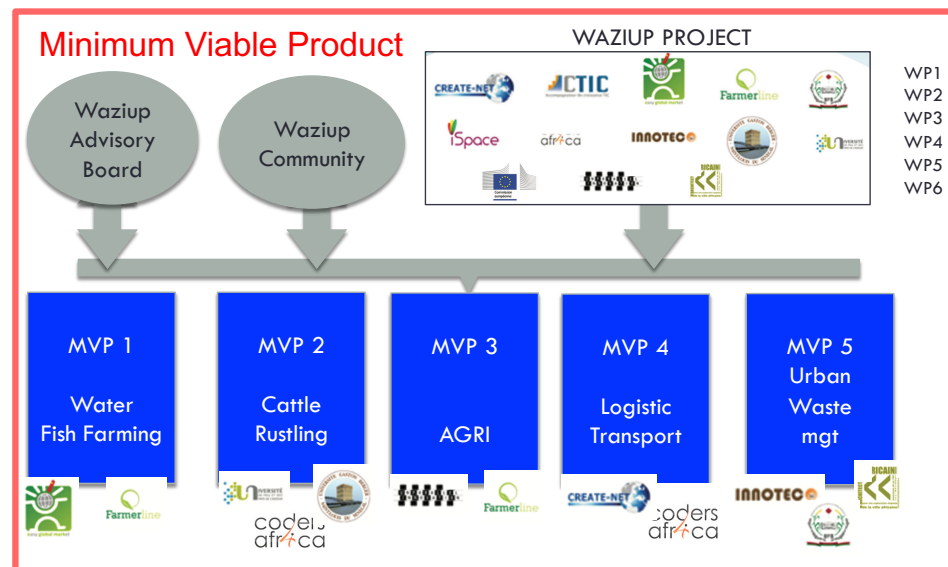




AND MUCH MORE!



- The WAZIUP IoT platform can be adapted/tailored/extended for specific vertical IoT domains in a production/business context



- The flexibility of the IoT platform allows for easy prototyping and fast integration of innovative research propositions



Thanks.
Let's keep in touch



Carine VAVASSEUR

Communication & Event Manager

Carine.vavasseur@cticdakar.com

www.cticdakar.com
contact@cticdakar.com



facebook.com/waziupIoT



twitter.com/waziupIoT



linkedin.com/groups/8156933



github.com/waziup